

---

DOC Investigation Nos. A-560-844, A-570-211,  
A-552-851, C-560-845, C-570-212, and C-552-852  
ITC Investigation Nos. 701-TA-\_\_\_ and 731-TA-\_\_\_  
Total Pages: 361  
Investigation  
AD/CVD Operations  
Petitioner Business Proprietary Information Removed  
from Pages 2-3, 5, 16-17, 20-21, 23, 25-26, 29, 30- 39, 41,  
Exhibit List, and Exhibits I-1 - I-2, I-5, I-6, I-18 - I-20 of  
this Volume  
PUBLIC VERSION

---

---

**BEFORE THE  
INTERNATIONAL TRADE ADMINISTRATION OF THE  
U.S. DEPARTMENT OF COMMERCE  
AND THE  
U.S. INTERNATIONAL TRADE COMMISSION**

---

**PETITIONS FOR THE IMPOSITION OF  
ANTIDUMPING AND COUNTERVAILING DUTIES PURSUANT TO  
SECTIONS 701 AND 731 OF THE TARIFF ACT OF 1930, AS AMENDED**

**VOLUME I:  
COMMON ISSUES AND INJURY PETITION**

---

**IN THE MATTER OF:  
HARDWOOD AND DECORATIVE PLYWOOD  
FROM INDONESIA, THE PEOPLE'S REPUBLIC OF CHINA,  
AND THE SOCIALIST REPUBLIC OF VIETNAM**

---

**PETITIONER:  
COALITION FOR FAIR TRADE IN HARDWOOD PLYWOOD**

---

**ECONOMIC CONSULTANTS:**

**Richard F. DiDonna, *International Trade Analyst*  
Amy M. Sherman, *International Trade Analyst*  
Carol Sayeg, *International Trade Consultant***

**WILEY TRADE ANALYTICS GROUP  
2050 M Street, NW  
Washington, DC 20036  
(202) 719-7000**

**May 22, 2025**

---

**COUNSEL:**

**Timothy C. Brightbill  
Stephanie M. Bell  
Stephen A. Morrison**

**WILEY REIN LLP  
2050 M Street, NW  
Washington, DC 20036  
(202) 719-7000**

**TABLE OF CONTENTS**

	<b>Page</b>
I. INTRODUCTION .....	1
II. EXECUTIVE SUMMARY .....	1
III. COMMON ISSUES.....	4
A. The Names and Addresses of the Petitioner (19 C.F.R. § 351.202(b)(1)).....	4
B. Identity of the Industry on Whose Behalf the Petition Is Filed (19 C.F.R. § 207.11(b)(2)(ii); 19 C.F.R. § 351.202(b)(2)) .....	4
C. Information Relating to the Degree of Industry Support for the Petition (19 C.F.R. § 351.202(b)(3)) .....	5
D. Previous Requests for Import Relief for the Merchandise (19 C.F.R. § 351.202(b)(4)) .....	6
E. Scope of the Investigation and a Detailed Description of the Subject Merchandise (19 C.F.R. § 351.202(b)(5)) .....	6
1. Scope of Investigation.....	6
2. Technical Characteristics and Uses .....	9
3. Production Methodology .....	13
4. Tariff Classification .....	14
F. The Names of the Home Market Countries and the Name of Any Intermediate Country Through Which the Merchandise Is Transshipped (19 C.F.R. § 351.202(b)(6)) .....	16
G. The Names and Addresses of Each Person Believed to Sell the Merchandise at LTNV and the Proportion of Total Exports to the United States (19 C.F.R. § 351.202(b)(7)(i)(A)) .....	17
H. Factual Information Related to the Calculation of Normal Value of the Foreign Like Product in Non-Market Economy Countries (19 C.F.R. § 351.202(b)(7)(i)(C)) .....	18
I. The Names and Addresses of Each Person Believed to Benefit from a Countervailable Subsidy Who Exports the Subject Merchandise to the United States and the Proportion of Total Exports to the United States (19 C.F.R. § 351.202(b)(7)(ii)(A)).....	18
J. The Alleged Countervailable Subsidy and Factual Information Relevant to the Alleged Countervailable Subsidy (19 C.F.R. § 351.202(b)(7)(ii)(B)).....	18
K. The Volume and Value of the Merchandise Imported During the Most Recent Three-Year Period (19 C.F.R. § 351.202(b)(8)).....	19

L.	The Names and Addresses of Each Entity the Petitioner Believes Imports or Is Likely to Import the Subject Merchandise (19 C.F.R. § 207.11(b)(2)(iii); 19 C.F.R. § 351.202(b)(9)).....	20
IV.	DUMPED AND SUBSIDIZED SUBJECT IMPORTS ARE A CAUSE OF MATERIAL INJURY AND THREAT THEREOF TO THE DOMESTIC HARDWOOD AND DECORATIVE PLYWOOD INDUSTRY .....	20
A.	Introduction.....	20
B.	The Domestic Like Product Consists of Hardwood and Decorative Plywood Covered by the Scope.....	21
C.	There Is a Single Domestic Industry Consisting of All Domestic Producers.....	23
D.	Subject Imports Are Causing Material Injury to the Domestic Industry .....	23
1.	The Commission Should Cumulate Subject Imports.....	24
2.	Subject Imports Are Not Negligible .....	27
3.	Conditions of Competition.....	28
4.	The Volume of Subject Imports Is Significant .....	30
5.	The Subject Imports Have Had Negative Price Effects on the Domestic Like Product .....	31
6.	The Adverse Impact of Subject Imports on the Domestic Industry Is Significant.....	36
E.	Subject Imports Threaten Material Injury to the Domestic Industry .....	39
V.	CONCLUSION.....	45

## **I. INTRODUCTION**

These Petitions are presented on behalf of the Coalition for Fair Trade in Hardwood Plywood (the “Coalition” or “Petitioner”).<sup>1</sup> The Coalition alleges that hardwood and decorative plywood imported from the People’s Republic of China (“China”), Indonesia, and the Socialist Republic of Vietnam (“Vietnam”) are being or are likely to be sold at less than fair value within the meaning of section 731 of the Tariff Act of 1930, *codified as amended*, 19 U.S.C. § 1673 (hereinafter “the Act”) and are being subsidized within the meaning of section 701 of the Act and 19 U.S.C. § 1671. These unfairly traded imports have materially injured the U.S. industry producing hardwood and decorative plywood and threaten to cause further material injury if relief is not granted. These Petitions contain information reasonably available to Petitioner in support of these allegations.

Separate volumes regarding the allegations of dumping by subject producers, as well as countervailable subsidies provided to subject producers, are being filed simultaneously at the U.S. Department of Commerce (the “Department”) and the U.S. International Trade Commission (the “Commission”). Petitioner requests that antidumping and countervailing duties be imposed to offset the dumping and subsidies detailed in the antidumping and countervailing duty volumes.

## **II. EXECUTIVE SUMMARY**

This Petition addresses the market-distorting and anticompetitive practices that have harmed, and further threaten the vitality of, the U.S. hardwood and decorative plywood industry. The U.S. hardwood and decorative plywood industry has long been injured by unfairly traded imports. In 2012, the domestic industry first sought to address this injury by filing a petition on

---

<sup>1</sup> The Coalition is comprised of U.S. manufacturers of hardwood and decorative plywood Columbia Forest Products, Commonwealth Plywood Inc., Manthei Wood Products, States Industries Inc., and Timber Products Company.

Chinese hardwood plywood, but this ultimately resulted in a negative determination by the Commission.<sup>2</sup> In 2016, the domestic industry again sought trade relief as Chinese producers of hardwood plywood continued to target the U.S. market with large volumes of dumped and subsidized merchandise.<sup>3</sup> This investigation resulted in an affirmative determination of material injury and, in January 2018, the Department issued antidumping and countervailing duty orders on hardwood plywood from China (the “*Hardwood Plywood from China Orders*”).<sup>4</sup>

However, even while the first case was underway, Chinese and other producers quickly switched tactics to continue their unfair trade practices. First, Chinese companies began producing and exporting softwood-faced decorative plywood that fell outside of the scope of the *Hardwood Plywood from China* investigations but directly competed with—and offered as a direct substitute for—the covered goods.<sup>5</sup> Next, producers in Vietnam, often related to or supported by the Chinese industry, began minor manufacturing and assembly operations using Chinese materials in an effort to circumvent the duties.<sup>6</sup> Finally, after affirmative circumvention determinations by the Department stopped this practice, Vietnamese and Indonesian producers rapidly expanded their manufacturing operations and production.<sup>7</sup> All of these dumped and subsidized imports quickly proliferated in the U.S. market. As a result, just as the domestic industry began to see relief in a

---

<sup>2</sup> See *Hardwood Plywood from China*, Inv. Nos. 701-TA-490 and 731-TA-1204, USITC Pub. 4434 (Nov. 2013) (Final) (“USITC Pub. 4434”).

<sup>3</sup> See *Hardwood Plywood from China*, Inv. Nos. 701-TA-565 and 731-TA-1341, USITC Pub. 4747 (Dec. 2017) (Final) at 3 (“USITC Pub. 4747”).

<sup>4</sup> *Id.* at 1; *Certain Hardwood Plywood Products from the People’s Republic of China*, 83 Fed. Reg. 504 (Dep’t Commerce Jan. 4, 2018) (amended final deter. of sales at less than fair value, and antidumping duty order); *Certain Hardwood Plywood Products from the People’s Republic of China*, 83 Fed. Reg. 513 (Dep’t Commerce Jan. 4, 2018) (countervailing duty order).

<sup>5</sup> See Declaration of [ **Name** ], attached as **Exhibit I-1**.

<sup>6</sup> *Id.*

<sup>7</sup> *Id.*

decline of Chinese imports as a result of the 2016 petition, imports from Indonesia and Vietnam and out of scope imports from China increased substantially. In short, the domestic industry never received the relief to which it was entitled.

During the period of investigation (“POI”), subject imports entered the United States in massive volumes, accounting for between [ # ] percent of apparent domestic consumption (“ADC”) by volume during the POI.<sup>8</sup> In the first quarter of 2025, subject imports have increased further and now account for [ # ] percent of ADC. The low and declining average unit values (“AUV”) of this massive influx of subject imports during the POI forced domestic producers to sharply decrease their prices in an attempt to maintain sales volumes. But, over time, as import prices continued to decline, major customers stopped even allowing domestic producers the opportunity to compete for these sales, as they were replaced by dumped and subsidized subject imports.

Increased pressure from these unfairly traded imports has resulted in severe adverse effects on the domestic industry. Over the POI, the domestic industry was forced to lower prices notwithstanding increasing costs. This has caused domestic operating income and net income to plummet, and U.S. companies have been forced to lay off workers and reduce hours. And despite lowering prices to remain competitive, domestic producers have continued to lose significant amounts of sales and revenue to unfairly traded imports from China, Indonesia, and Vietnam.

This situation only threatens to further deteriorate. Production capacity in China, Indonesia, and Vietnam has continued to increase, and much of this capacity is specifically dedicated to

---

<sup>8</sup> See Import Shipment & Market Share Analysis, attached as **Exhibit I-2**.

targeting the U.S. market. As these imports continue to increase, prices will continue to crater, and domestic manufacturing of hardwood and decorative plywood will struggle to remain viable.

### III. COMMON ISSUES

This section contains information required in antidumping and countervailing duty petitions by the regulations of the Department<sup>9</sup> and the Commission.<sup>10</sup>

#### A. The Names and Addresses of the Petitioner (19 C.F.R. § 351.202(b)(1))

The Petitioner is the Coalition for Fair Trade in Hardwood Plywood. Petitioner is a domestic interested party within the meaning of 19 U.S.C. § 1677(9)(F) and 19 C.F.R. § 351.102(b)(17).<sup>11</sup> The names, addresses, and telephone numbers for the companies comprising the Coalition are provided in **Exhibit I-3**.<sup>12</sup>

#### B. Identity of the Industry on Whose Behalf the Petition Is Filed (19 C.F.R. § 207.11(b)(2)(ii); 19 C.F.R. § 351.202(b)(2))

These Petitions are filed on behalf of the U.S. industry that produces hardwood and decorative plywood, as described in the scope. In addition to information relating to Petitioner, the names, addresses, and telephone numbers of other domestic producers in the United States are provided in **Exhibit I-4**.<sup>13</sup> According to the best information available to Petitioner, **Exhibits I-3** and **I-4** identify all known producers of the domestic like product in the United States.<sup>14</sup>

---

<sup>9</sup> 19 C.F.R. §§ 351.202(b)(1)-(10), (b)(12).

<sup>10</sup> *Id.* § 207.11.

<sup>11</sup> In addition, individual members of the Coalition are domestic interested parties within the meaning of 19 U.S.C. § 1677(9)(C) and 19 C.F.R. § 351.102(b)(17).

<sup>12</sup> List of Petitioners and Contact Information, attached as **Exhibit I-3**.

<sup>13</sup> Non-Petitioner U.S. Hardwood Plywood Manufacturers, attached as **Exhibit I-4**.

<sup>14</sup> *Id.*; List of Petitioners and Contact Information, attached as **Exhibit I-3**.

**C. Information Relating to the Degree of Industry Support for the Petition (19 C.F.R. § 351.202(b)(3))**

Under the relevant statutory provisions, a petition is filed by or on behalf of the domestic industry if: (1) domestic producers who support the petition account for at least 25 percent of the total production of the domestic like product, and (2) domestic producers who support the petition account for more than 50 percent of the production of the domestic like product produced by that portion of the industry expressing support for or opposition to the petition.<sup>15</sup> To the best of its knowledge, Petitioner meets both of these requirements.

Petitioner’s estimate of total U.S. production of hardwood and decorative plywood for 2024 is in the table below. Petitioner has estimated the quantity of U.S. hardwood and decorative plywood production using industry-wide data [ narrative

].<sup>16</sup> This data represents the best information available to Petitioner and is a reasonable representation of domestic production.

As **Table 1** shows, Petitioner’s estimated share of U.S. production of hardwood and decorative plywood [ ] exceeded 50 percent in 2024.

**TABLE 1  
PETITIONER’S SHARE OF DOMESTIC PRODUCTION<sup>17</sup>**

	2024
<b>Domestic Production</b>	[ # ]
<b>Petitioner’s Production</b>	[ # ]
<b>Petitioner’s Share</b>	[ # ]

<sup>15</sup> 19 U.S.C. § 1671a(c)(4)(A) (countervailing duty petitions) and § 1673a(c)(4)(A) (antidumping petitions).

<sup>16</sup> See Declaration of [ Name ], attached as **Exhibit I-5**.

<sup>17</sup> See *id.*; Petitioner’s Trade and Financial Data, attached as **Exhibit I-6**.



Thus, Petitioner has the requisite industry support to file these petitions on behalf of the domestic industry.

**D. Previous Requests for Import Relief for the Merchandise (19 C.F.R. § 351.202(b)(4))**

Petitioner's member companies have previously filed for antidumping and countervailing duty relief on imports of hardwood plywood from the People's Republic of China.<sup>18</sup> These investigations resulted in affirmative determinations by the Department and the Commission, resulting in the imposition of the *Hardwood Plywood from China* Orders.

Hardwood plywood was also subject to antidumping and countervailing duty investigations that concluded in 2014, *Hardwood Plywood from China*, Investigation Nos. 701-TA-490 and 731-TA-1204. These investigations resulted in a negative determination by the Commission.<sup>19</sup>

Petitioner has not filed for relief from imports of the subject merchandise under sections 337 of the Act, section 301 of the Trade Act of 1974 ("Section 301"), or section 232 of the Trade Expansion Act of 1962 ("Section 232").<sup>20</sup>

**E. Scope of the Investigation and a Detailed Description of the Subject Merchandise (19 C.F.R. § 351.202(b)(5))**

**1. *Scope of Investigation***

The physical characteristics of the covered products, which define the scope, are as follows:

---

<sup>18</sup> USITC Pub. 4747.

<sup>19</sup> See USITC Pub. 4434.

<sup>20</sup> Petitioner and members of the Coalition filed comments expressing support for maintaining Section 301 tariffs on certain Harmonized Tariff Schedule of the United States ("HTSUS") codes covered by the scope of this investigation. Additionally, the Department has initiated a Section 232 investigation covering timber, lumber, and their derivative products. See *Notice of Request for Public Comments on Section 232 Nat'l Sec. Investigation of Imports of Timber and Lumber*, 90 Fed. Reg. 11,941 (Dep't Commerce Mar. 13, 2025) ("Section 232 Investigation NRPC"). These investigations were self-initiated by the U.S. Department of Commerce and neither Petitioner nor individual members of the Coalition petitioned the U.S. government for Section 232 relief. The Coalition filed comments in response to the Section 232 Investigation NRPC.

The merchandise covered by the investigations is hardwood and decorative plywood, and certain veneered panels as described below. For purposes of this proceeding, hardwood and decorative plywood is defined as a generally flat, multilayered plywood or other veneered panel, consisting of two or more layers or plies of wood veneers in combination with a core or without a core. The veneers, along with the core, may be glued or otherwise bonded together. A hardwood and decorative plywood panel must have at least either the face or back veneer composed of one or more species of hardwood, softwood, or bamboo. Hardwood and decorative plywood may include products that meet the American National Standard for Hardwood and Decorative Plywood, ANSI/HPVA HP-1-2024 (including any revisions to that standard).

For purposes of the investigations a “veneer” is a slice of wood regardless of thickness which is cut, sliced or sawed from a log, bolt, or flitch. The face and back veneers are the outermost veneer of wood on either side of the core irrespective of additional surface coatings or covers as described below. The core of hardwood and decorative plywood consists of the layer or layers of one or more material(s) that are situated between the face and back veneers. The core may be composed of a range of materials, including but not limited to hardwood, softwood, particleboard, or medium density fiberboard (MDF).

All hardwood and decorative plywood is included within the scope of the investigations regardless of whether or not the face and/or back veneers are surface coated or covered and whether or not such surface coating(s) or covers obscures the grain, textures, or markings of the wood. Examples of surface coatings and covers include, but are not limited to: ultra violet light cured polyurethanes; oil or oil-modified or water-based polyurethanes; wax; epoxy-ester finishes; moisture-cured urethanes; paints; stains; paper; aluminum; high pressure laminate; MDF; medium density overlay (MDO); and phenolic film. Additionally, the face veneer of hardwood and decorative plywood may be sanded; smoothed or given a “distressed” appearance through such methods as hand-scraping or wire brushing.

All hardwood and decorative plywood is included within the scope even if it is trimmed; cut-to-size; notched; punched; drilled; or has undergone other forms of minor processing. All hardwood and decorative plywood is included within the scope of the investigation, without regard to dimension (overall thickness, thickness of face veneer, thickness of back veneer, thickness of core, thickness of inner veneers, width, or length). However, the most common panel sizes of hardwood and decorative plywood are 1219 x 1829 mm (48 x 72 inches), 1219 x 2438 mm (48 x 96 inches), and 1219 x 3048 mm (48 x 120 inches). Subject merchandise also includes hardwood and decorative plywood that has been further processed in a third country, including but not limited to trimming, cutting, notching, punching, drilling, or any other processing that would not otherwise remove the merchandise from the scope of the investigations if performed in the country of manufacture of the in-scope product.

The scope of the investigation excludes the following items: (1) structural plywood (also known as “industrial plywood” or “industrial panels”) that (a) is certified, manufactured, and stamped to meet U.S. Products Standard PS 1-09, PS 2-09, PS-122, or PS 2-10 for Structural Plywood (including any revisions to that standard or any substantially equivalent international standard intended for structural plywood), including, but not limited to, the “bond performance” requirements set forth at paragraph 5.8.6.4 of that Standard and the performance criteria detailed at Tables 4 through 10 of that Standard, and (b) has a core made entirely of one or more of the following wood species: *Pseudotsuga menziesii* (Douglas Fir), *Larix occidentalis* (Western Larch), *Tsuga heterophylla* (Western Hemlock), *Abies* spp. (True Firs like Grand Fir, Pacific Silver Fir), *Picea* spp. (White Spruce, Engelmann Spruce), *Pinus* spp. (Lodgepole Pine, Jack Pine), *Picea glauca* (White Spruce), *Pinus banksiana* (Jack Pine), and *Abies balsamea* (Balsam Fir); (2) products which have a face and back veneer of cork; (3) hardwood plywood subject to the antidumping and countervailing duty orders on hardwood plywood from China. *See Hardwood Plywood Products from the People’s Republic of China*, 83 Fed. Reg. 504 (Dep’t Commerce Jan. 4, 2018) (amended final determination of sales at less than fair value (LTFV) and AD order); and *Hardwood Plywood Products from the People’s Republic of China*, 83 FR 513 (Jan. 4, 2018) (CVD order); (4) multilayered wood flooring, as described in the antidumping duty and countervailing duty orders on multilayered wood flooring from China. *See Multilayered Wood Flooring from the People’s Republic of China*, 76 Fed. Reg. 76,690 (December 8, 2011) (amended final determination of sales at less than fair value (LTFV) and AD order); and *Multilayered Wood Flooring from the People’s Republic of China*, 76 Fed. Reg. 76,693 (Dep’t Commerce December 8, 2011) (countervailing duty order), as amended by *Multilayered Wood Flooring from the People’s Republic of China: Amended Antidumping and Countervailing Duty Orders*, 77 Fed. Reg. 5,484 (Dep’t Commerce February 3, 2012); (5) multilayered wood flooring with a face veneer of bamboo or composed entirely of bamboo; (6) plywood which has a shape or design other than a flat panel, with the exception of any minor processing described above; (7) products made entirely from bamboo and adhesives (also known as “solid bamboo”); and (8) Phenolic Film Faced Plyform (PFF), also known as Phenolic Surface Film Plywood (PSF), defined as a panel with an “Exterior” or “Exposure 1” bond classification as is defined by The Engineered Wood Association, having an opaque phenolic film layer with a weight equal to or greater than 90g/m<sup>3</sup> permanently bonded on both the face and back veneers and an opaque, moisture resistant coating applied to the edges.

Also excluded from the scope of the investigations are wooden furniture goods that, at the time of importation, are fully assembled and are ready for their intended uses. Also excluded from the scope of the investigations is “ready to assemble” (RTA) furniture. RTA furniture is defined as (A) furniture packaged for sale for ultimate purchase by an end-user that, at the time of importation, includes (1) all wooden components (in finished form) required to assemble a finished unit of furniture, (2) all accessory parts (e.g., screws, washers, dowels, nails, handles, knobs, adhesive

glues) required to assemble a finished unit of furniture, and (3) instructions providing guidance on the assembly of a finished unit of furniture; (B) unassembled bathroom vanity cabinets, having a space for one or more sinks, that are imported with all unassembled hardwood and hardwood plywood components that have been cut-to-final dimensional component shape/size, painted or stained prior to importation, and stacked within a singled shipping package, except for furniture feet which may be packed and shipped separately; or (C) unassembled bathroom vanity linen closets that are imported with all unassembled hardwood and hardwood plywood components that have been cut-to-final dimensional shape/size, painted or stained prior to importation, and stacked within a single shipping package, except for furniture feet which may be packed and shipped separately.

Also excluded from the scope of the investigations are kitchen cabinets that, at the time of importation, are fully assembled and are ready for their intended uses. Also excluded from the scope of the investigations are RTA kitchen cabinets. RTA kitchen cabinets are defined as kitchen cabinets packaged for sale for ultimate purchase by an end-user that, at the time of importation, includes: (1) all wooden components (in finished form) required to assemble a finished unit of cabinetry; (2) all accessory parts (e.g., screws, washers, dowels, nails, handles, knobs, hooks, adhesive glues) required to assemble a finished unit of cabinetry; and (3) instructions providing guidance on the assembly of a finished unit of cabinetry. Excluded from the scope of the investigations are finished table tops, which are table tops imported in finished form with pre-cut or drilled openings to attach the underframe or legs. The table tops are ready for use at the time of import and require no further finishing or processing. Excluded from the scope of the investigations are finished countertops that are imported in finished form and require no further finishing or manufacturing.

## 2. *Technical Characteristics and Uses*

Hardwood and decorative plywood is a panel composed of an assembly of two or more layers or plies of wood veneer(s) either in combination with a core or without. The several layers, either with or without the core, are glued or otherwise bonded together to form a finished product.<sup>21</sup> Hardwood and decorative plywood panels can be composed of one or more species of hardwoods, softwoods, or bamboo (in addition to other materials that are used for the core, as detailed below). Products with veneers (face and/or back) of bamboo are treated as subject in the list of HTSUS

---

<sup>21</sup> See, e.g., *How is Plywood Made?*, Curtis Lumber & Plywood (July 11, 2019), attached as **Exhibit I-7**.

codes below, as they were in the prior investigation on hardwood plywood. Moreover, the ANSI/HPVA HP-1-2024 applies to plywood made with hardwood, softwood, or bamboo face, back and/or inner plies.<sup>22</sup>

Hardwood and decorative plywood has a wide variety of uses, including, but not limited to, wall panels, kitchen cabinet components, seat backs, table and desktops, drawer sides, furniture components, recreational vehicle and trailer components, floor underlayment, and the raw material for certain engineered (*i.e.*, multilayered) wood flooring. Hardwood and decorative plywood is generally intended for interior (*i.e.*, indoor) uses.<sup>23</sup>

Hardwood and decorative plywood is primarily manufactured as a panel. Some of the most common panel sizes are 1219 x 1829 mm (48 x 72 inches), 1219 x 2438 mm (48 x 96 inches), and 1219 x 3048 (48 x 120 inches). However, these panels are often cut-to-size by the manufacturer in accordance with a customer's requirements, or made to other sizes. The most common thicknesses of the panels range from 3.2 mm (1/8 inch) to 25.4 mm (1 inch). Regardless of the actual dimensions, all products that meet the description herein are intended for inclusion within the definition of subject merchandise.

Hardwood and decorative plywood is typically comprised of a core sandwiched between two veneers. However, hardwood and decorative plywood may also come in different configurations, including as few as two veneers with no core, or a core with a single veneer. A "veneer" is a thin slice of wood, rotary cut, sliced or sawed from a log, bolt, or flitch. The face veneer is the exposed veneer of a plywood panel. It is generally of superior grade to that of the

---

<sup>22</sup> See American Nat'l Standard Inst., *ANSI/HPVA HP-1 2024*, American Nat'l Standard for Hardwood and Decorative Plywood (approved Aug. 20, 2024) at 4, attached as **Exhibit I-8** ("The species for the face, back, and inner plies shall be from any hardwood, softwood, or woody grass.").

<sup>23</sup> See *id.* at 35-36.

other veneer of the plywood panel (*i.e.*, as opposed to the inner veneers).<sup>24</sup> Depending on material costs and competitive market forces, exposed decorative veneers are cut in a wide range of thicknesses. The vast majority of exposed decorative veneers are cut in the range of 1/100 inch (.25 mm) to 1/27 inch (.91 mm). If both faces of the plywood are to be exposed, both veneers will be face veneers, and typically will be of the same grade.

The core of hardwood and decorative plywood consists of the layer or layers of material(s) that are generally situated between the face and back veneers. The core may be composed of a number of materials, including, but not limited to, veneers of hardwood or softwood, particleboard, MDF, hardboard, lumber, oriented strand board, or a combination of two or more core types.<sup>25</sup> Veneer core “platforms” are included in the definition of subject merchandise. A veneer core platform is defined as two or more wood veneers that form the core of an otherwise completed hardwood and decorative plywood product (*i.e.*, a hardwood and decorative plywood product to which the outer (face and/or back) veneers have not yet been affixed).

Hardwood and decorative plywood is generally described by the number of veneers; overall thickness; width; length; species of face veneer; grade of face and/or back veneer; thickness of face veneer; pattern or type of cut of face veneer; and type of core.<sup>26</sup> Because hardwood and decorative plywood is typically used for decorative purposes, the appearance of the face veneer and, where exposed, the back veneer, is often an important feature. For this reason, grades are assigned to the face and back veneers. The grade reflects such characteristics as color streaks or

---

<sup>24</sup> *See id.* at 34.

<sup>25</sup> *See id.* at 33.

<sup>26</sup> *See, e.g., id.* at 1-3. While some customers may specify the thickness of the face veneer, this thickness is not generally considered significant. Rather, to a large extent, the thickness of the face veneer is determined by the manufacturing process used, with the one-step process generally resulting in thicker face veneers than the two-step process.

spots, color variations, burls, and pin knots. Some U.S. manufacturers offer proprietary or custom grades. However, the consensus grading standards are set forth in ANSI/HPVA HP-1 2024.<sup>27</sup> Face grades are delineated as AA, A, B, C, D, or E (listed in descending order). Back grades are delineated as 1, 2, 3, or 4 (listed in descending order).<sup>28</sup>

Hardwood and decorative plywood included within the definition of subject merchandise may be “unfinished” or “prefinished.” An unfinished product has not had a surface coating applied to the face and/or back veneers to protect the face and/or back veneers from wear and tear. Prefinished products, on the other hand, have such a surface coating. Typical finishes include, but are not limited to, ultra-violet light cured polyurethanes, oil or oil-modified or water-based polyurethanes, wax, epoxy-ester finishes, and moisture-cured urethanes. The face and/or back veneers of hardwood and decorative plywood may be sanded, smoothed or given a “distressed” appearance through such methods as hand-scraping or wire brushing. The face ply may also be stained, to achieve a particular color. The scope includes coatings that may cause the grain, texture, or markings on the wood to be obscured, including, but not limited to, paper, aluminum, HPL, MDF, MDO, and phenolic film.

All hardwood and decorative plywood is included within the definition of subject merchandise, without regard to dimensions, including overall thickness, thickness of the face ply, thickness of back ply, thickness of core, and thickness of inner plies; width and length; wood species used for the face, back and inner veneers (including hardwoods, softwoods, or bamboo); core composition; and face and/or back grade. As noted above, the product may be “unfinished” or “prefinished.” The face of the product may be sanded, smoothed, or stained.

---

<sup>27</sup> *See id.*

<sup>28</sup> *See id.* at 1.

Rotary-cut veneer is made using a lathe that spins a log against a blade at very high speed. This makes a continuous layer of thin veneer that is then cut to the desired length and width, typically 50 inches by 100 inches in order to produce a finished panel of 48 inches by 96 inches (4 x 8 feet). Alternatively, veneers may be produced by slicing or sawing. Sliced or sawed veneers are thin sheets cut from lumber, flitches, or blocks of wood. They are cut into variable lengths and widths depending upon the form and dimension of the wood raw material. Sliced veneer typically has a different grain pattern than rotary-cut veneer and is often utilized to make higher grades and specialty plywood.<sup>29</sup>

Whether rotary-produced or sliced, veneer is cut to thicknesses ranging from as thin as 0.01 inch (0.25 mm) to greater than 1/4 inch (6.35 mm). Veneer is graded and sorted by quality, then dried prior to use in hardwood and decorative plywood manufacturing. Face veneers may be, but are not always, produced at a separate facility or by a different company than the manufacturer of hardwood plywood.<sup>30</sup>

### 3. *Production Methodology*

The production process of hardwood and decorative plywood begins with the debarking of logs of a size and quality suitable for peeling slicing to make veneer. Veneer quality logs, or peeler logs, are generally of higher quality and value than those used for other products, although the quality of veneer from any given log will vary.<sup>31</sup>

---

<sup>29</sup> See, e.g., *Veneer Cuts and Matching*, Columbia Forest Products Website Excerpt (last accessed May 1, 2025), attached as **Exhibit I-9**.

<sup>30</sup> See USITC Pub. 4747 at I-15 – I-16.

<sup>31</sup> See, e.g., David Mercker, *Quality Hardwood Veneer*, University of Tennessee Agricultural Extension Service (May 2004), attached as **Exhibit I-10**.



Some U.S. producers employ a “one-step” process which is fully automated, continuous system from the log to the finished product. In the “one-step” process, face and back veneers are glued and pressed at the same time as core veneers. The other prevalent system, referred to as a “two-step” process, takes face and back veneers and combines them with a “core” or “platform” that is manufactured separately. Some U.S. producers use the “two-step” process.

In many cases, face veneers that are of a particular species and grade are purchased from other veneer producers and are then glued onto the core material to complete the manufacturing process. Prior to pressing the face and core veneers are dried, sorted for defects, repaired or patched, taped, or stitched to make longer sheets from smaller pieces, and trimmed. The veneers are stacked with their grain in alternating directions in order to provide strength and stability to the finished product. Depending on the manufacturing process, a cold press may be used to fabricate the several plies of veneer together prior to being hot pressed to glue the veneers together.<sup>32</sup> The thickness and number of plies depends upon the product.

After pressing and trimming, panels are sanded and, in some cases, finished depending on the end use. Finishing can involve some degree of texturing for a particular appearance, grooving, and/or staining or coloring. The process will vary somewhat if a core of composite wood (e.g., MDF or particleboard) or other material is used.<sup>33</sup>

#### 4. *Tariff Classification*

There is no set tariff classification for hardwood and decorative plywood. Imports of hardwood and decorative plywood are primarily entered under the following HTSUS numbers: 4412.10.0500; 4412.31.0520; 4412.31.0540; 4412.31.0560; 4413.31.0620; 4412.31.0640;

---

<sup>32</sup> See *Plywood Production Process*, Yalong Wood (Jan. 19, 2021), attached as **Exhibit I-11**.

<sup>33</sup> USITC Pub. 4434 at I-11.

PUBLIC VERSION

4412.31.0660; 4412.31.2510; 4412.31.2520; 4412.31.2610; 4412.31.2620; 4412.31.4040;  
4412.31.4050; 4412.31.4060; 4412.31.4070; 4412.31.4080; 4412.31.4140; 4412.31.4150;  
4412.31.4155; 4412.31.4160; 4412.31.4165; 4412.31.4180; 4412.31.4200; 4412.31.4500;  
4412.31.4850; 4412.31.4860; 4412.31.4863; 4412.31.4865; 4412.31.4866; 4412.31.4869;  
4412.31.4875; 4412.31.4880; 4412.31.5130; 4412.31.5135; 4412.31.5150; 4412.31.5155;  
4412.31.5160; 4412.31.5165; 4412.31.5170; 4412.31.5175; 4412.31.5235; 4412.31.5255;  
4412.31.5260; 4412.31.5262; 4412.31.5264; 4412.31.5265; 4412.31.5266; 4412.31.5268;  
4412.31.5270; 4412.31.5275; 4412.31.6000; 4412.31.6100; 4412.31.9100; 4412.31.9200;  
4412.32.0520; 4412.32.0540; 4412.32.0560; 4412.32.0570; 4412.32.0620; 4412.32.0640;  
4412.32.0670; 4412.32.2510; 4412.32.2520; 4412.32.2530; 4412.32.2610; 4412.32.2630;  
4412.32.3130; 4412.32.3135; 4412.32.3140; 4412.32.3150; 4412.32.3155; 4412.32.3160;  
4412.32.3165; 4412.32.3170; 4412.32.3175; 4412.32.3185; 4412.32.3235; 4412.32.3255;  
4412.32.3265; 4412.32.3275; 4412.32.3285; 4412.32.5600; 4412.32.5700; 4412.33.0620;  
4412.33.0640; 4412.33.0670; 4412.33.2630; 4412.33.3235; 4412.33.3255; 4412.33.3265;  
4412.33.3275; 4412.33.3285; 4412.33.5700; 4412.34.2600; 4412.34.3235; 4412.34.3255;  
4412.34.3265; 4412.34.3275; 4412.34.3285; 4412.34.5700; 4412.39.4051; 4412.39.4052;  
4412.39.4059; 4412.39.4061; 4412.39.4062; 4412.39.4069; 4412.39.5050; 4412.41.0000;  
4412.42.0000; 4412.51.1030; 4412.51.1050; 4412.51.3111; 4412.51.3121; 4412.51.3141;  
4412.51.3161; 4412.51.3175; 4412.51.4100; 4412.52.1030; 4412.52.1050; 4412.52.3121;  
4412.52.3161; 4412.52.3175; 4412.52.4100; 4412.91.0600; 4412.91.1020; 4412.91.1030;  
4412.91.1040; 4412.91.3110; 4412.91.3120; 4412.91.3130; 4412.91.3140; 4412.91.3150;  
4412.91.3160; 4412.91.3170; 4412.91.4100; 4412.92.0700; 4412.92.1120; 4412.92.1130;  
4412.92.1140; 4412.92.3120; 4412.92.3150; 4412.92.3160; 4412.92.3170; 4412.92.4200;

4412.94.1020; 4412.94.1030; 4412.94.1040; 4412.94.1050; 4412.94.3110; 4412.94.3111;  
 4412.94.3120; 4412.94.3121; 4412.94.3130; 4412.94.3131; 4412.94.3140; 4412.94.3141;  
 4412.94.3150; 4412.94.3160; 4412.94.3161; 4412.94.3170; 4412.94.3171; 4412.94.3175;  
 4412.94.4100; 4412.99.0600; 4412.99.1020; 4412.99.1030; 4412.99.1040; 4412.99.3110;  
 4412.99.3120; 4412.99.3130 4412.99.3140; 4412.99.3150; 4412.99.3160; 4412.99.3170;  
 4412.99.4100; 4412.99.5100; 4412.99.5115; 4412.99.5701; and 4412.99.5710. These are also the  
 import categories which [ **namd**] and Coalition members regularly monitor.

Imports of hardwood and decorative plywood may also enter under HTSUS subheadings  
 4412.10.9000; 4412.94.5100; 4412.94.9500; 4412.99.6000; 4412.99.7000; 4412.99.8000;  
 4412.99.9000; 4412.99.9500; 9403.90.7005; 9403.90.7010; and 9403.90.7080.

Excerpts from the current HTSUS are attached as **Exhibit I-12**. The HTSUS codes are  
 provided for the convenience of the U.S. government and do not define the scope of the petition.  
 The written description of the merchandise under investigation is dispositive.<sup>34</sup>

**F. The Names of the Home Market Countries and the Name of Any Intermediate Country Through Which the Merchandise Is Transshipped (19 C.F.R. § 351.202(b)(6))**

The hardwood and decorative plywood covered by these Petitions is imported from China, Indonesia, and Vietnam. Petitioner does not have any evidence indicating that the subject merchandise is currently produced in a country other than that from which it is exported. Petitioner notes that U.S. Customs and Border Protection (“CBP”) has initiated a number of investigations

<sup>34</sup> The HTSUS codes under which imports of hardwood and decorative plywood are entered has changed since the investigations on *Hardwood Plywood from China* due to changes in the HTSUS code.

under the Enforce and Protect Act with regard to merchandise subject to the *Hardwood Plywood from China* Orders that was transshipped through Cambodia.<sup>35</sup>

**G. The Names and Addresses of Each Person Believed to Sell the Merchandise at LTNV and the Proportion of Total Exports to the United States (19 C.F.R. § 351.202(b)(7)(i)(A))**

The names and addresses of the Chinese, Indonesian, and Vietnamese entities believed by Petitioner to be producing and exporting hardwood and decorative plywood subject to these Petitions are provided in **Exhibit I-16**.<sup>36</sup> In compiling this exhibit, Petitioner relied primarily upon information publicly available online, information procured from [ **Name** ], and Petitioner's industry knowledge.

Information reasonably available to Petitioner does not allow it to identify the proportion of total exports to the United States accounted for during the most recent 12-month period by the producers listed in this exhibit. Petitioner believes, however, the companies listed in **Exhibit I-16** account for the vast majority of subject imports.<sup>37</sup>

---

<sup>35</sup> See, e.g., Letter from U.S. Customs and Border Protection to InterGlobal Forest, Inc., et. al., re: *Notice of Initiation of Investigation and Interim Measures – APA Cons. Case 7321* (Oct. 1, 2019), attached as **Exhibit I-13**; Memorandum from Kristina Horgan, Chief, EAPA Invs. Branch, to Africa Bell, Acting Dir., Enft Operations Div., re: *Initiation of Investigation for EAPA Case Number 7323 – American Pacific Plywood* (June 26, 2019), attached as **Exhibit I-14**; Memorandum from Kristina Horgan, Chief, EAPA Invs. Branch, to Africa Bell, Acting Dir., Enft Operations Div., re: *Initiation of Investigation for EAPA Case Number 7327 – U.S. Global Forest, Inc.* (June 26, 2019), attached as **Exhibit I-15**.

<sup>36</sup> List of Known Foreign Producers, attached as **Exhibit I-16**.

<sup>37</sup> *Id.*

**H. Factual Information Related to the Calculation of Normal Value of the Foreign Like Product in Non-Market Economy Countries (19 C.F.R. § 351.202(b)(7)(i)(C))**

China and Vietnam are treated as non-market economies for antidumping purposes.<sup>38</sup>

Volumes III and IV of these petitions contains the information necessary to substantiate LTNV allegations and factual information relevant to China and Vietnam.

**I. The Names and Addresses of Each Person Believed to Benefit from a Countervailable Subsidy Who Exports the Subject Merchandise to the United States and the Proportion of Total Exports to the United States (19 C.F.R. § 351.202(b)(7)(ii)(A))**

The names and addresses of the Chinese, Indonesian, and Vietnamese entities believed by Petitioner to be benefiting from countervailable subsidies and who have exported the hardwood and decorative plywood subject to these petitions are provided in **Exhibit I-16**.<sup>39</sup> Information reasonably available to Petitioner does not allow it to identify the proportion of total exports to the United States accounted for during the most recent 12-month period by the producers listed in this exhibit. As stated above, Petitioner believes, however, that the companies listed in **Exhibit I-16** account for the majority of subject imports.<sup>40</sup>

**J. The Alleged Countervailable Subsidy and Factual Information Relevant to the Alleged Countervailable Subsidy (19 C.F.R. § 351.202(b)(7)(ii)(B))**

Volumes V, VI, and VII of these petitions contain information concerning the alleged countervailable subsidies as well as factual information relevant to the alleged countervailable

---

<sup>38</sup> See *Raw Honey From the Socialist Republic of Vietnam*, 89 Fed. Reg. 64,411 (Dep't Commerce Aug. 7, 2024) (final results of antidumping duty changed circumstance review) ("Commerce finds {that Vietnam} remains a non-market economy (NME) country for purposes of U.S. antidumping duty (AD) law due to the sustained and pervasive government influence over its country's economic activities."); Preliminary Decision Memorandum accompanying *Certain Hardwood Plywood Products from the People's Republic of China*, 89 Fed. Reg. 66,346 (Dep't Commerce Aug. 15, 2024) (prelim. results of antidumping duty admin. rev., prelim. deter. of no shipments, and partial rescission; 2021-2022) (ACCESS Barcode: 4610399-02) at 14.

<sup>39</sup> List of Known Foreign Producers, attached as **Exhibit I-16**.

<sup>40</sup> *Id.*

subsidies, the law, regulations, and decrees under which the subsidies were bestowed, the manner in which the subsidies were provided, and Petitioner's estimation—to the extent practicable—of the value of the subsidies to subject producers and exporters of hardwood and decorative plywood subject to these petitions.

**K. The Volume and Value of the Merchandise Imported During the Most Recent Three-Year Period (19 C.F.R. § 351.202(b)(8))**

Consistent with the regulations, Petitioner provides here the volume and value of subject imports during the most recent three calendar years and the first quarter of 2025:<sup>41</sup>

**Table 2**  
**Subject Imports (in square feet)**

	2022	2023	2024	Q1 2024	Q1 2025
China	66,388,992	99,494,912	134,909,952	32,628,736	38,602,752
Indonesia	942,687,516	603,022,803	729,662,536	163,695,368	295,329,331
Vietnam	792,509,307	431,149,555	637,841,350	206,162,446	196,532,883
Total	1,801,585,815	1,133,667,270	1,502,413,838	402,486,550	530,464,966

**Table 3**  
**Subject Imports (in USD)**

	2022	2023	2024	Q1 2024	Q1 2025
China	34,120,040	38,262,445	43,210,347	10,297,765	12,774,413
Indonesia	680,632,121	282,499,846	337,587,563	76,930,483	105,522,435
Vietnam	400,723,593	185,998,824	244,072,528	67,431,203	73,151,992
Total	1,115,475,754	506,761,115	624,870,438	154,659,450	191,448,840

<sup>41</sup> Import Shipment & Market Share Analysis, attached as **Exhibit I-2**. Import data for Indonesia and Vietnam includes both import data for hardwood plywood and decorative plywood. Import data for China excludes any hardwood plywood that is currently subject to the *Hardwood Plywood from China* Orders. Thus, in compiling import data for subject import data from China, Petitioner excluded any imports under HTSUS codes that are explicitly covered by the *Hardwood Plywood from China* Orders. Additionally, some products from Vietnam are currently subject to the *Hardwood Plywood from China* Orders as a result of an affirmative circumvention determination. Petitioner estimates that approximately three percent of Vietnamese imports are covered and, thus, reduced import volumes by three percent to estimate the total amount of subject imports.

**L. The Names and Addresses of Each Entity the Petitioner Believes Imports or Is Likely to Import the Subject Merchandise (19 C.F.R. § 207.11(b)(2)(iii); 19 C.F.R. § 351.202(b)(9))**

The names and addresses of importers of hardwood and decorative plywood from China, Indonesia, and Vietnam known to Petitioner at this time are listed in **Exhibit I-17**.<sup>42</sup> Petitioner believes, however, that there may be additional importers of subject merchandise that it has been unable to identify. Petitioner respectfully requests that the Department and the Commission obtain this information from CBP, as Petitioner does not have access to this complete information.

**IV. DUMPED AND SUBSIDIZED SUBJECT IMPORTS ARE A CAUSE OF MATERIAL INJURY AND THREAT THEREOF TO THE DOMESTIC HARDWOOD AND DECORATIVE PLYWOOD INDUSTRY**

**A. Introduction**

Imports of hardwood and decorative plywood from China, Indonesia, and Vietnam have caused material injury to the domestic industry. Unfairly traded hardwood and decorative plywood imports from the subject countries have been substantial in the past three years. Subject imports in 2023 were [ trend ] total U.S. production of hardwood and decorative plywood, and in 2022 and 2024, subject imports [ trend ] that of domestic production. These already low-priced imports declined further in price during the POI, forcing the domestic industry to lower its prices as well in order to compete for sales, despite experiencing increases in costs and expenses. This caused the domestic industry's operating and net income to plummet by [ # ] and [ # ] percent, respectively, and caused already low capacity utilization levels to decrease even further.<sup>43</sup> In the first quarter of 2025, the domestic industry attempted to [ narrative ]

---

<sup>42</sup> List of Known U.S. Importers, attached as **Exhibit I-17**.

<sup>43</sup> See Petitioner's Trade and Financial Data, attached as **Exhibit I-6**.

]. However, even with these efforts, the domestic industry still [ trend ] on each sale.

Despite the domestic industry's earlier efforts during the POI to maintain market share by [ # ], subject imports took at least \$[ # ] in sales from the domestic industry during the POI.<sup>44</sup> Subject imports also pose a threat of further material injury to the domestic industry. Because subject imports have undermined the domestic industry's financial performance, the industry is at heightened risk of further material injury from the subject imports. As the domestic industry [ Narrative ], subject imports will take even more sales volume and revenue from the domestic industry, further weakening an already vulnerable industry.

**B. The Domestic Like Product Consists of Hardwood and Decorative Plywood Covered by the Scope**

In determining whether an industry in the United States is materially injured or threatened with material injury by reason of imports of the subject merchandise, the Commission first defines the domestic like product.<sup>45</sup> The "domestic like product" is defined as "a product which is like, or in the absence of like, most similar in characteristics and uses with, the article subject to an investigation . . . ."<sup>46</sup> The like product determination is a factual one made on a case-by-case basis.<sup>47</sup> The Commission generally considers the following factors: (1) physical characteristics and uses; (2) interchangeability; (3) channels of distribution; (4) customer and producer perceptions of the products; (5) common manufacturing facilities, production processes and production

---

<sup>44</sup> Lost Sales and Lost Revenues, attached as **Exhibit I-18**.

<sup>45</sup> *See NEC Corp. v. Dep't of Commerce*, 36 F. Supp. 2d 380, 382 (Ct. Int'l Trade 1998).

<sup>46</sup> 19 U.S.C. § 1677(10).

<sup>47</sup> *See, e.g., NEC Corp.*, 36 F. Supp. 2d at 383.



employees; and, where appropriate, (6) price.<sup>48</sup> In evaluating these factors, the Commission looks for clear dividing lines and disregards minor variations.<sup>49</sup>

In *Hardwood Plywood from China*, the Commission determined that there was a single like product.<sup>50</sup> The Commission made the following findings with respect to the relevant criteria:

- All hardwood plywood shares the same physical characteristics;
- All hardwood plywood is used in a range of interior applications;
- All hardwood plywood is made using one of two production processes;
- All hardwood plywood is sold through the same channels of distribution;
- Hardwood plywood is sold on the basis of grade, type of core, overall panel thickness, and face species. Higher grades are used in visually important areas, while lower grades are used as shelves and in the back of cabinets;
- Hardwood plywood price is a function of quality or grade of the veneer and the composition of the core.
- Producer and customer perceptions recognize differences in the species, veneer quality, thickness, number of plies, type of core, and the type of adhesive used in the manufacturing process.<sup>51</sup>

Based on these factors, the Commission determined that hardwood plywood consisted of a single domestic like product.

There have been no significant changes with respect to any of these factors since the prior investigation. Indeed, in the 2023 sunset review of *Hardwood Plywood from China*, the Commission again defined a single domestic like product coextensive with the scope.<sup>52</sup>

---

<sup>48</sup> See *Cleo, Inc. v. United States*, 501 F.3d 1291, 1295 (Fed. Cir. 2007).

<sup>49</sup> See *id.*

<sup>50</sup> See *Hardwood Plywood from China*, Inv. Nos. 701-TA-565 and 731-TA-1341, USITC Pub. 4661 (Jan. 2017) (Prelim.) at 8-9 (“USITC Pub. 4661”), *unchanged in* USITC Pub. 4747 at 9-10.

<sup>51</sup> USITC Pub. 4661 at 8-9, *unchanged in* USITC Pub. 4747 at 9-10.

<sup>52</sup> *Hardwood Plywood from China*, Inv. Nos. 701-TA-565 and 731-TA-1341, USITC Pub. 5426 (May 2023) (Rev.) at 10-11 (“USITC Pub. 5426”).

And, while the scope in this investigation has been expanded to also include decorative plywood made with softwood veneers, this analysis does not change. This softwood-faced decorative plywood was expressly designed to serve as a replacement for hardwood plywood in order to avoid paying duties under the *Hardwood Plywood from China* Orders.<sup>53</sup>

The Commission should accordingly determine that hardwood and decorative plywood represents a single domestic like product, coextensive with the scope identified above.

**C. There Is a Single Domestic Industry Consisting of All Domestic Producers**

Section 771(4)(A) of the Act defines the domestic industry as the domestic “producers as a whole of a domestic like product, or those producers whose collective output of a domestic like product constitutes a major proportion of the total domestic production of the product.”<sup>54</sup> In the prior investigation of and the sunset review of *Hardwood Plywood from China*, the Commission determined there was a single domestic industry producing hardwood plywood.<sup>55</sup> The Commission should again find that there is a single domestic industry consisting of all U.S. producers of hardwood and decorative plywood in these investigations.

**D. Subject Imports Are Causing Material Injury to the Domestic Industry**

In determining whether a domestic industry is experiencing present material injury caused by unfairly traded imports, the Commission considers:

- (1) the volume of imports of the subject merchandise;
- (2) the effect of imports of that merchandise on prices in the United States for domestic like products; and

---

<sup>53</sup> Declaration of [ **Name** ], attached as **Exhibit I-19**; Emails Discussing Pine-Faced Decorative Plywood, attached as **Exhibit I-20**.

<sup>54</sup> 19 U.S.C. § 1677(4)(A).

<sup>55</sup> See USITC Pub. 4747 at 10-12; USITC Pub. 5426 at 12.

- (3) the impact of imports of such merchandise on domestic producers of domestic like products.<sup>56</sup>

An analysis of these factors shows that the domestic hardwood and decorative plywood industry is suffering material injury by reason of subject imports.

### 1. *The Commission Should Cumulate Subject Imports*

For purposes of evaluating the volume and price effects for a determination of material injury by reason of subject imports, section 771(7)(G)(i) of the Act requires the Commission to cumulate subject imports from all countries as to which petitions were filed on the same day, if such imports compete with each other and with the domestic like product in the U.S. market.<sup>57</sup> In assessing whether subject imports compete with each other and with the domestic like product, the Commission generally has considered four factors:

- (1) the degree of fungibility between subject imports from different countries and between subject imports and the domestic like product . . . ;
- (2) the presence of sales or offers to sell in the same geographic markets of subject imports from different countries and the domestic like product;
- (3) the existence of common or similar channels of distribution for subject imports from different countries and the domestic like product; and
- (4) whether the subject imports are simultaneously present in the market.<sup>58</sup>

While no single factor is necessarily determinative, and the list of factors is not exhaustive, these factors are intended to provide the Commission with a framework for determining whether the subject imports compete with each other and with the domestic like product.<sup>59</sup> Only a “reasonable overlap” of competition is required.

---

<sup>56</sup> 19 U.S.C. § 1677(7)(B).

<sup>57</sup> *Id.* § 1677(7)(G)(i). None of the exceptions to cumulation apply. *See id.* § 1677(7)(G)(ii).

<sup>58</sup> *See Certain Cast-Iron Pipe Fittings from Brazil, the Republic of Korea, and Taiwan*, Inv. Nos. 731-TA-278-280, USITC Pub. 1845 (May 1986) (Final) at 8 n.29, *cf. d.*, *Fundicao Tupy, S.A. v. United States*, 12 CIT 6, 6-7 (1988), *cf. d.*, *Fundicao Tupy, S.A. v. United States*, 859 F.2d 915, 915 (Fed. Cir. 1988).

<sup>59</sup> *See, e.g., Wieland Werke, AG v. United States*, 13 CIT 561, 565-67 (1989).

Each of the Commission's factors indicates that the imports subject to these petitions compete with each other and with the domestic like product. First, hardwood and decorative plywood produced in the subject countries and in the United States are highly fungible. Indeed, the Commission has previously found that hardwood plywood from China and domestic hardwood plywood are substitutable.<sup>60</sup> Information collected by the Commission also shows that domestic and Chinese hardwood plywood are substitutable with hardwood plywood from other countries.<sup>61</sup> Likewise, decorative plywood made with softwood veneers is substitutable with hardwood plywood. Indeed, many companies in the subject countries offer such decorative plywood as a direct substitute for hardwood plywood.<sup>62</sup> Moreover, the number of lost sales identified in **Exhibit I-18** confirms that hardwood and decorative plywood from any subject country can easily be substituted for domestically produced hardwood and decorative plywood.<sup>63</sup>

Second, the record here will show that imports from each of the subject countries compete with imports from the other subject countries and with the domestic like product throughout the U.S. market. Hardwood and decorative plywood, regardless of source, is sold nationwide, with the ability to be used throughout the country. For example, Columbia Forest Products has manufacturing facilities in the South, Northeast, Midwest and West, and its products are sold

---

<sup>60</sup> See, e.g., USITC Pub. 4747 at 18-21.

<sup>61</sup> See, e.g., *id.* at Tables II-13 and II-14.

<sup>62</sup> Declaration of [ **Name** ], attached as **Exhibit I-19**; Emails Discussing Pine-Faced Decorative Plywood, attached as **Exhibit I-20**.

<sup>63</sup> Lost Sales and Lost Revenue, attached as **Exhibit I-18**.

nationwide in big box stores like Home Depot.<sup>64</sup> Moreover, hardwood and decorative plywood from subject countries are present in every region of the United States.<sup>65</sup>

Third, the imports from the subject countries and the domestic like product are sold through the same channels of distribution: to distributors and end users. The record will demonstrate that subject imports and the domestic like product compete directly in all channels. For example, the [ description of what happened ].<sup>66</sup>

Finally, the subject imports and the domestic like product have been simultaneously present in the U.S. market throughout the POI. Import data show that subject imports from each country entered in every month of the POI.<sup>67</sup> Hardwood and decorative plywood produced by domestic producers were also present in the U.S. market throughout the POI.<sup>68</sup>

In sum, these Petitions are being filed on the same day, and subject imports compete with each other and with the domestic like product in the U.S. market, thereby satisfying the threshold requirement for cumulation. Subject imports from each subject country are fungible with the domestic like product and each other, subject imports from each subject country and the domestic like product are sold in the same channels of distribution and in similar geographic markets, and subject imports from each subject country and the domestic like product have been simultaneously present in the U.S. market. As such, there is a reasonable overlap of competition between the domestic like product and imports from each subject country and between imports from each

---

<sup>64</sup> *Manufacturing Locations*, Columbia Forest Products Website Excerpt (last accessed May 1, 2025), attached as **Exhibit I-21**; *Columbia Forest Products*, Home Depot Website Excerpt (last accessed May 1, 2025), attached as **Exhibit I-22**.

<sup>65</sup> Subject Imports by Region, attached as **Exhibit I-23**.

<sup>66</sup> See Lost Sales and Lost Revenues, attached as **Exhibit I-18**.

<sup>67</sup> See Subject Imports by Month, attached as **Exhibit I-24**.

<sup>68</sup> See Petitioner's Trade and Financial Data, attached as **Exhibit I-6**.

subject country. The Commission should therefore analyze subject imports on a cumulated basis for its analysis of whether the domestic industry is materially injured by reason of subject imports.

## 2. *Subject Imports Are Not Negligible*

The Commission generally will consider imports from a subject country to be negligible if they account for less than 3 percent of total imports of the subject merchandise.<sup>69</sup> The Commission may make its determination using “reasonable estimates on the basis of available statistics . . . .”<sup>70</sup> The Commission has discretion when choosing what source to rely on to determine negligibility.<sup>71</sup> In assessing negligibility, the Commission will examine “the most recent 12-month period for which data are available that precedes” the filing of the petition.<sup>72</sup>

The most recent 12-month period for which data are available is April 2024 – March 2025. As shown in **Exhibit I-25** import data establish that, during this period, subject imports from China, Indonesia, and Vietnam accounted for 4.31 percent, 26.33 percent, and 19.21 percent of imports, respectively.<sup>73</sup> As such, imports from these countries exceeded the negligibility threshold and thus satisfy the statutory threshold for investigation.

---

<sup>69</sup> 19 U.S.C. §§ 1673b(a)(1), 1673d(b)(1), 1677(24)(A)(i).

<sup>70</sup> *Certain Oil Country Tubular Goods from India, Korea, the Philippines, Taiwan, Thailand, Turkey, Ukraine, and Vietnam*, Inv. Nos. 701-TA-499-500 and 731-TA-1215-1217 and 1219-1223, USITC Pub. 4489 (Sept. 2014) (Final) at 16.

<sup>71</sup> *See, e.g., Certain Cold-Rolled Steel Products from Argentina, Brazil, Japan, Russia, South Africa, and Thailand*, Inv. Nos. 701-TA-393 and 731-TA-829-830, 833-834, 836 and 838, USITC Pub. 3283 (Mar. 2000) (Final) at 9-10.

<sup>72</sup> 19 U.S.C. § 1677(24)(A)(i).

<sup>73</sup> *See* Negligibility Analysis, attached as **Exhibit I-25**.

### 3. *Conditions of Competition*

#### a. **Hardwood and Decorative Plywood Is Primarily Sold on the Basis of Price**

Price is a key condition of competition in the hardwood and decorative plywood industry. The Commission has previously found that there is a moderate degree of substitutability between domestically produced and foreign produced hardwood plywood, and that price was the second most important purchasing factor.<sup>74</sup> Indeed, in the investigation of *Hardwood Plywood from China*, the Commission found that “a substantial number of purchasers purchased subject hardwood plywood instead of the domestic product because it was lower priced” and that “the underselling observed during the period of investigation could not be explained by differences in non-price factors.”<sup>75</sup> Here too, U.S. hardwood and decorative plywood competes with subject imports on the basis of price.

#### b. **Hardwood and Decorative Plywood Demand is Tied to Demand for Downstream Products**

In the *Hardwood Plywood from China* investigation, the Commission found that demand for hardwood and decorative plywood is driven by demand in downstream products such as kitchen cabinets, recreational vehicles, manufactured homes, fixtures, underlayment and furniture.<sup>76</sup> In turn, demand in these industries is driven by new home construction, remodeling activity, and U.S. economic activity more generally.<sup>77</sup>

U.S. economic growth and demand in the specific industries that drive hardwood and decorative plywood demand have softened and are projected to weaken further. The COVID-19

---

<sup>74</sup> See USITC Pub. 4747 at 18.

<sup>75</sup> *Id.* at 23.

<sup>76</sup> *Id.* at 16.

<sup>77</sup> *Id.* at 16, II-7; USITC Pub. 5426 at 16.

pandemic increased demand for housing and remodeling projects, which led to increased residential housing starts that peaked in 2021.<sup>78</sup> In 2022, demand reached a POI peak, with imports totaling over 1.8 billion square feet, approximately [ amount

].<sup>79</sup> As demand fell in 2023 following the COVID-19 housing and remodeling boom, subject imports declined somewhat, but still continued to enter the United States in massive quantities. Likewise, subject imports decreased in 2023, particularly those from Vietnam, due to the affirmative circumvention determination which led to a temporary reduction of imports from Vietnam. Then, in 2024, despite demand remaining relatively even from 2023, subject imports increased by 32.5 percent year-over-year.<sup>80</sup> Subject imports have continued to surge in 2025, increasing 31.8 percent in the first quarter of 2025 as compared to the first quarter of 2024.

With future demand unclear, the domestic industry is particularly vulnerable to unfairly traded subject imports. In the first quarter of 2025, the United States' GDP contracted by 0.3 percent, the first contraction in U.S. GDP in three years.<sup>81</sup> Given that many economists believe that both the United States economy and global economy are headed towards a downturn or recession,<sup>82</sup> demand for hardwood and decorative plywood is likely to be flat at best, as new home construction, remodeling, and purchases of new furniture are likely to decline. Should demand decline, even

---

<sup>78</sup> See *Single-Family Starts Down in December but Post Solid Showing*, National Association of Home Builders (Jan. 18, 2024), attached as **Exhibit I-26**.

<sup>79</sup> See *Import Shipment & Market Share Analysis*, attached as **Exhibit I-2**.

<sup>80</sup> See *id.*

<sup>81</sup> See Sarah Hansen, *Is the US Headed for a Recession? What Analysts Are Saying About Q1's GDP Decline*, Morningstar (Apr. 30, 2025), attached as **Exhibit I-27**; Lauren Aratani, *U.S. economy shrinks in first quarter of Trump 2.0 amid sweeping tariffs*, The Guardian (Apr. 30, 2025), attached as **Exhibit I-28**.

<sup>82</sup> *The probability of a recession remains at 60%*, J.P. Morgan (Apr. 15, 2025), attached as **Exhibit I-29**; Paul Davidson, *Economy will likely slow to near standstill or recession despite Trump tariff pause: Survey*, USA Today (Apr. 14, 2025), attached as **Exhibit I-30**.



marginally, domestic producers are likely to be squeezed out of the market as subject imports continue to surge into the U.S. at low prices.

**4. The Volume of Subject Imports Is Significant**

In evaluating the volume of imports, the Commission considers whether the absolute and relative volumes of imports, as well as changes in volumes, are significant. The available data show that the volume of subject imports, both in absolute terms and relative to U.S. consumption is significant within the meaning of the relevant statutory provision.

**a. The Volume of Subject Imports Is Significant in Absolute Terms**

The volume of subject imports was significant in absolute terms during the POI. As seen below in **Table 4**, imports of hardwood and decorative plywood from the subject countries were significant throughout the POI, accounting for between 1.13 and 1.8 *billion* square feet per year during the POI.

**TABLE 4<sup>83</sup>**  
**IMPORTS OF HARDWOOD AND DECORATIVE PLYWOOD**

	2022	2023	2024	Q1 2024	Q1 2025
China	66,388,992	99,494,912	134,909,952	32,628,736	38,602,752
Indonesia	942,687,516	603,022,803	729,662,536	163,695,368	295,329,331
Vietnam	792,509,307	431,149,555	637,841,350	206,162,446	196,532,883
Total Subject Imports	1,801,585,815	1,133,667,270	1,502,413,838	402,486,550	530,464,966
All Other Imports	1,924,162,725	1,933,192,963	1,654,210,960	420,270,501	406,222,926

By way of comparison, total U.S. shipments of hardwood and decorative plywood in 2022, 2023, and 2024 was [ # ] square feet, respectively.<sup>84</sup> In other words, throughout the POI, subject imports maintained a significant presence in the U.S. market.

<sup>83</sup> See Import Shipment & Market Share Analysis, attached as **Exhibit I-2**.

<sup>84</sup> See *id.*

**b. Subject Import Market Share Was Significant During the Period**

Given their substantial presence throughout the POI, it is unsurprising that subject imports also accounted for a significant portion of the U.S. market. As shown in **Table 5**, subject imports’ market share remained significant throughout the POI. Subject imports accounted for between [ # ] and [ # ] percent of ADC by quantity during the POI. And now, in the first quarter of 2025, subject imports account for [ # ] percent of hardwood and decorative plywood in the U.S. market. While U.S. producers’ market share remained relatively [ ] during the POI, data from the first quarter of 2025 show that the domestic industry is [ trend ] market share.<sup>85</sup>

**TABLE 5<sup>86</sup>  
MARKET SHARE BY QUANTITY 2022-2024 (%)**

	2022	2023	2024	Q1 2024	Q1 2025
U.S. Industry	[				]
China Subject	[				]
Indonesia	[				]
Vietnam Subject	[				]
Total Subject Imports	[				]
China Non-Subject	[				]
Vietnam Non-Subject	[				]
Total Non-Subject Imports	[				]

**5. The Subject Imports Have Had Negative Price Effects on the Domestic Like Product**

In evaluating the effect of subject imports on prices, the Commission must consider whether there has been significant underselling by the subject imports, and whether imports significantly suppressed or depressed domestic prices.<sup>87</sup> As discussed above, by volume, subject

<sup>85</sup> See id.

<sup>86</sup> See id.

<sup>87</sup> 19 U.S.C. § 1677(7)(C)(ii).

imports [ trend ] outsold domestic like product. Despite this, the total value of subject imports is [ trend ] to domestic sales volumes.<sup>88</sup> This is the result of subject imports being priced substantially below U.S. products.<sup>89</sup> As discussed in more detail below, the significantly lower—and falling—AUVs of subject imports have had a domino effect on the domestic industry, and have led to significant lost sales and revenue, and falling AUVs of domestic like product. On this basis, the Commission should determine that subject imports had significant negative price effects on the domestic like product.

**a. Subject Imports Compete Directly with the Domestic Like Product**

As an initial matter, subject imports compete directly with the domestic like product, as dumped and subsidized subject imports serve all geographic markets in the United States and are interchangeable with hardwood and decorative plywood produced by U.S. producers. Being comparable in all other major respects, subject imports and the domestic like product compete primarily on the basis of price, meaning subject producers can use unfair pricing to take sales and capture market share.

**b. Subject Imports Undersold the Domestic Like Product**

Subject imports undersold the domestic like product throughout the POI. As **Table 6** below shows, subject imports consistently and significantly undersold the domestic like product. Indeed, across the POI, AUVs for subject countries averaged only [ # ] percent of the AUVs for domestic shipments. As a result of these significantly low—and declining—prices and the dominance of price in purchasing decisions, the domestic industry has significant lost sales during the POI.

---

<sup>88</sup> See Import Shipment & Market Share Analysis, attached as **Exhibit I-2**.

<sup>89</sup> Petitioner's Trade and Financial Data, attached as **Exhibit I-6**.

Indeed, U.S. producers reported that, during the POI, they lost sales to subject imports worth more than [ ].<sup>90</sup>

**TABLE 6<sup>91</sup>**  
**AVERAGE UNIT VALUES (in USD/square foot)**

	2022	2023	2024	Q1 2024	Q1 2025
U.S. Commercial Shipments	[				]
China	\$0.51	\$0.38	\$0.32	\$0.32	\$0.33
Indonesia	\$0.72	\$0.47	\$0.46	\$0.47	\$0.36
Vietnam	\$0.51	\$0.43	\$0.38	\$0.33	\$0.37
All Subject Imports	\$0.62	\$0.45	\$0.42	\$0.38	\$0.36
Non-Subject Imports	\$0.67	\$0.44	\$0.54	\$0.51	\$0.54

The Commission will need to collect detailed information regarding domestic and subject products to assess the extent of underselling in this investigation. Petitioner recommends that the Commission collect data on the following pricing products:

- Product 1.** 12 mm (1/2") thickness (actual or nominal), 4x8 panel size, Birch face (whether white birch, natural birch, or artisan birch; whole piece), face grade C/D+ or substantially equivalent, Birch back (whether white birch, natural birch, or artisan birch), back grade 2/3 or substantially equivalent, veneer core, unfinished.
- Product 2.** 12 mm (1/2") thickness (actual or nominal), 4x8 panel size, Birch face (whether white birch, natural birch or artisan birch; whole piece), face Grade C/D+ or substantially equivalent, Birch back (whether white birch, natural birch or artisan birch), back grade 2/3 or substantially equivalent, veneer core, prefinished.
- Product 3.** 18 mm (3/4") thickness (actual or nominal), 4x8 panel size, Birch face (whether white birch, natural birch or artisan birch), face Grade C/D+ or substantially equivalent, Birch back (whether white birch, natural birch or artisan birch), back grade 2/3 or substantially equivalent, veneer core, unfinished.
- Product 4.** 5.2 mm (1/4") thickness (actual or nominal), 4x8 panel size, Maple face (whether plain or rotary sliced), face Grade B or substantially equivalent,

<sup>90</sup> See Lost Sales and Lost Revenue, attached at **Exhibit I-18**. This is a conservative estimate, as many of the lost sales reports include the quantity, but not the value of, the lost sales.

<sup>91</sup> See Petitioner's Trade and Financial Data, attached as **Exhibit I-6**.

Maple back (whether plain or rotary sliced), back grade 2/3 or substantially equivalent, veneer core, unfinished.

**Product 5.** 18 mm (3/4”) thickness (actual or nominal), 4x8 panel size, Birch face (whether white birch, natural birch or artisan birch), face Grade C/D+ or substantially equivalent, Birch back (whether white birch, natural birch or artisan birch), back grade 2/3 or substantially equivalent, veneer core, prefinished.

**Product 6.** 5.2 mm (1/4”) thickness (actual or nominal), 4x8 panel size, Birch face (whether plain or rotary sliced), face Grade C or substantially equivalent, back face of Birch or other, Grade 2/3 or substantially equivalent, veneer core, unfinished.

In Petitioner’s view, the Commission does not need to add additional pricing products for softwood-faced decorative products. Because softwood-faced decorative products were designed to compete directly with these pricing products, importers that are importing the same or similar product with a softwood face should report the pricing product data for the corresponding product, and also report the softwood species used to make the product. However, to the extent that the Commission deems it appropriate to include a separate pricing product for softwood-faced decorative products, Petitioner proposes the following pricing product:

**Product 7.** 18 mm (3/4”) thickness (actual or nominal), 4x8 panel size, Pine face (whether plain or rotary sliced), face Grade C or substantially equivalent, Pine back (whether plain or rotary sliced), back grade 2/3 or substantially equivalent, veneer core, unfinished.

**c. Subject Imports Suppressed and Depressed Domestic Prices**

The evidence also shows that subject imports have suppressed and depressed domestic prices. The AUVs for domestic hardwood and decorative plywood [ [narrative description](#) ] between 2022 and 2024.<sup>92</sup> Over the same period, AUVs for subject imports declined by

---

<sup>92</sup> *See id.*

approximately 33 percent.<sup>93</sup> These declines in AUV occurred despite increases in cost of goods sold (“COGS”) and SG&A expenses, causing operating income to plummet. Net income per square foot fell from \$[ # ] dollars to only \$[ # ] dollars from 2022 to 2024, a decline of approximately [ #] percent.<sup>94</sup> As discussed above, while demand fell between 2022 and 2023, demand was relatively flat between 2023 and 2024. Under these circumstances, absent higher import volumes and lower import prices, domestic production and domestic prices should have risen or, at a minimum, remained flat.

Instead, the domestic industry was [ narrative ]. This is strong evidence that the rising level of subject imports, combined with their falling AUVs, suppressed domestic prices and prevented the domestic industry from capitalizing on the benefits of strong demand at the beginning of the POI, and preventing the domestic industry from increasing prices commensurate with increased costs of production. This price suppression is reflected in the deteriorating financial performance of the domestic hardwood and decorative plywood industry.

Further evidence of the negative price effects of the subject imports appears in the reports of lost sales and lost revenues. U.S. producers have identified lost sales totaling approximately [ amount ].<sup>95</sup> Again, these lost sales establish that subject imports are competing directly with the domestic like product, and that low AUVs for subject imports have a direct effect on domestic prices.

---

<sup>93</sup> See Import Shipment & Market Share Analysis, attached as **Exhibit I-2**.

<sup>94</sup> See Petitioner’s Trade & Financial Data, attached as **Exhibit I-6**.

<sup>95</sup> See Lost Sales and Lost Revenue, attached as **Exhibit I-18**. As noted above, these totals are conservative and do not include all lost sales and lost revenue.

**6. *The Adverse Impact of Subject Imports on the Domestic Industry Is Significant***

In examining the impact of subject imports on the domestic industry, the Commission is instructed to “evaluate all relevant economic factors which have a bearing on the state of the industry in the United States.”<sup>96</sup> These factors include, but are not limited to:

- (I) actual and potential decline in output, sales, market share, profits, productivity, return on investments, and utilization of capacity;
- (II) factors affecting domestic prices;
- (III) actual and potential negative effects on cash flow, inventories, employment, wages, growth, ability to raise capital, and investment;
- (IV) actual and potential negative effects on the existing development and production efforts of the domestic industry, including efforts to develop a derivative or more advanced version of the domestic like product; and
- (V) the magnitude of the margin of dumping.<sup>97</sup>

The Commission is directed to evaluate all factors “within the context of the business cycle and conditions of competition that are distinctive to the affected industry.”<sup>98</sup> A review of these factors shows substantial indicators of injury to the domestic industry by reason of the subject imports in this investigation.

**a. *Subject Imports Adversely Affected the Domestic Industry’s Financial Performance During the POI***

There can be no doubt that subject imports had a severe negative impact on the domestic industry’s financial performance during the POI. During the POI, Petitioner’s net operating income dropped by [ # ] percent, from nearly [ # ] in 2022 to only [ # ].<sup>99</sup> This [ ] decline in operating income was a direct result of competition from subject

<sup>96</sup> 19 U.S.C. § 1677(7)(C)(iii).

<sup>97</sup> *Id.* §§ 1677(7)(C)(iii)(I)-(V).

<sup>98</sup> *Id.* § 1677(7)(C)(iii).

<sup>99</sup> *See* Petitioner’s Trade and Financial Data, attached as **Exhibit I-6**.

imports during the POI. Despite increased COGS and SG&A expenses from 2022 to 2024, Petitioner was forced to [ trend ] in an attempt to maintain sales values in order to compete with subsidized and dumped subject imports.<sup>100</sup> Indeed, despite an overall increase of [ # ] per unit increase in combined COGS and SG&A from 2022 to 2024, Petitioner's AUV declined by [ # ].<sup>101</sup> Thus, instead of being able to increase—or at least maintain—prices during a time of increasing costs, prices dropped by [ # ] percent.<sup>102</sup>

**b. The Domestic Industry's Production and Trade Indicators Demonstrate the Injury Caused by Subject Imports**

Unfairly priced subject imports have negatively impacted the trade and financial performance of the domestic industry by taking substantial sales from U.S. producers. In 2022, U.S. demand for hardwood and decorative plywood was high, and yet U.S. producers were unable to take advantage due to massive quantities of subject imports.<sup>103</sup> Indeed, Petitioner's capacity utilization rates in 2022 was only [ # ] percent in 2022.<sup>104</sup> As demand cooled in 2023, capacity utilization fell to [ # ] percent in 2023 and 2024.<sup>105</sup> While Coalition members' commercial shipments dropped [ trend ] from 2022 to 2024, the value of those shipments dropped considerably, decreasing [ # ] percent over the POI.<sup>106</sup>

The decreased prices of domestic hardwood and decorative plywood were a last-ditch effort by the domestic industry to maintain its market share in the face of increasing volumes of

---

<sup>100</sup> See *id.*

<sup>101</sup> See *id.*

<sup>102</sup> See *id.*

<sup>103</sup> See Import Shipment & Market Share Analysis, attached as **Exhibit I-2**; Petitioner's Trade and Financial Data, attached as **Exhibit I-6**.

<sup>104</sup> See Petitioner's Trade and Financial Data, attached as **Exhibit I-6**.

<sup>105</sup> See *id.*

<sup>106</sup> See *id.*



subject imports entering at increasingly lower prices. While the domestic industry was able to [ trend ] its share of the market during the POI by [ narrative ], doing so took an immense financial toll on domestic producers. The need to [ trend]prices, combined with an [ trend ] in COGS and SG&A expenses during the POI, caused the domestic industry's operating income to plummet—[ #] percent—to the point where the domestic industry was barely able to [ trend ]. The domestic industry is now at a point where it can no longer [ narrative ] in order to stay competitive. The domestic industry is faced with either continuing to [ ] or [ narrative ].

If subject imports traded at unfair prices continue to proliferate in the U.S. market, domestic production capacity, shipments, and prices will drop precipitously. Without trade relief, the domestic industry will be forced to decrease production, shutter factories, and lay off workers. Indeed, declining profitability has already forced non-petitioning U.S. companies to lay off workers and close factories.<sup>107</sup> These major negative effects on American workers constitutes injury to the domestic industry caused by unfairly traded subject imports.

**c. Subject Imports Have Caused Domestic Producers to Lose Sales and Revenues**

Subject imports have used unfair pricing to take substantial sales and revenues from domestic producers in recent years. As discussed above, the industry has reached a point where it can no longer afford to [ narrative ] in order to stay competitive with dumped and subsidized subject imports.

---

<sup>107</sup> See, e.g., *Roseburg Forest Products Lays Off 2.5% of Its North American Workforce*, ForestNet (Dec. 20, 2024), attached as **Exhibit I-31**; *Besse Closing 3 Hardwood Veneer/Plywood Plants in Wisconsin*, Building Products Digest (Aug. 6, 2024), attached as **Exhibit I-32**.

As demonstrated in **Exhibit I-18**, Petitioner has identified lost sales and revenues with an estimated total value of over \$[ # ].<sup>108</sup> Total lost sales and revenue are undoubtedly significantly higher, as U.S. producers are often unable to decisively document their lost sales, particularly among lower volume purchasers that may not even offer U.S. producers an opportunity to obtain the business.

**d. The Estimated Dumping Margins Are High**

Coalition members have been forced to compete with imports dumped at substantial margins. Petitioner estimates dumping margins for the subject merchandise at the following levels:<sup>109</sup>

<b>Subject Country</b>	<b>Estimated Dumping Margin</b>
China	474.2%
Indonesia	202.8%
Vietnam	112.33% to 133.72%

**E. Subject Imports Threaten Material Injury to the Domestic Industry**

As the discussion above demonstrates, subject imports have caused material injury to the domestic hardwood and decorative plywood industry. Additionally, reasonably available evidence shows that subject imports threaten the domestic industry with further material injury.

As an initial matter, the Department should cumulate subject imports for its threat analysis. The Act provides that, in evaluating the threat of material injury, the Commission may

---

<sup>108</sup> Lost Sales and Lost Revenue, attached as **Exhibit I-18**.

<sup>109</sup> Petition for the Imposition of Antidumping Duties, *Certain Hardwood Plywood Products from Indonesia*, vol. II (Mar. 22, 2025) at 19-20; Petition for the Imposition of Antidumping Duties, *Certain Hardwood Plywood from People's Republic of China*, vol. III (Mar. 22, 2025) at 19; Petition for the Imposition of Antidumping Duties, *Certain Hardwood Plywood from the People's Republic of Vietnam*, vol. IV (Mar. 22, 2025) at 20.

cumulatively assess the volume and price effects of imports of the subject merchandise from all countries with respect to which the petitions were filed on the same day, “if such imports compete with each other and with domestic like products in the United States market.”<sup>110</sup> As these Petitions cover all of the subject countries, the first requirement is met. And as demonstrated above, the subject imports all compete with each other and with the domestic like product in the U.S. market. Thus, the statutory requirements for cumulation in a threat investigation have been satisfied.

In determining whether subject imports threaten a domestic industry with material injury, the Commission must consider a number of factors. These factors include:

- A significant rate of increase of the volume or market penetration of imports of the subject merchandise;
- Price effects of the subject imports;
- The nature of any countervailable subsidies;
- Existing unused production capacity or potential increases in production capacity in the exporting country;
- Inventories of the subject merchandise; and
- The potential for product-shifting.
- Any other demonstrable adverse trend that indicates there is likely to be material injury (whether or not it is actually being imported at the time).<sup>111</sup>

These factors are present in this case and will be shown throughout the investigation.

**Increase in Imports:** As discussed previously, demand for hardwood and decorative plywood declined between 2022 and 2023 as the booming pandemic housing market slowed as interest rates rose. However, despite steady demand between 2023 and 2024, available import data

---

<sup>110</sup> 19 U.S.C. § 1677(7)(G).

<sup>111</sup> *Id.* § 1677(7)(F)(i).

show that subject imports grew by nearly 33 percent.<sup>112</sup> This trend has continued in the first quarter of 2025, with subject imports increasing nearly 32 percent during the first quarter of 2025.

**Price Effects:** The Act provides that, in determining whether the domestic industry is threatened with material injury, the Commission should consider “whether imports of the subject merchandise are entering at prices that are likely to have a significant depressing or suppressing effect on domestic prices, and are likely to increase demand for further imports.”<sup>113</sup> This was the case during the POI and, in the absence of relief, prices will continue to decline in the near future.

Despite increasing costs of production, the AUVs of both subject imports and domestic like product fell.<sup>114</sup> The increasing volumes of dumped and subsidized imports undersold U.S. producers and prevented the domestic industry from raising its prices in response to these increased costs. And even as demand stabilized from 2023 to 2024, an increase in subject imports at increasingly lower AUVs forced U.S. producers to lower their prices even further.<sup>115</sup> Domestic prices have already been pushed [ narrative ]. Domestic producers can no longer [ narrative ] in order to compete for sales with subject imports.

**Nature of the Subsidies:** As part of its threat analysis, the Commission must consider “if a countervailable subsidy is involved” and, in particular, “whether the countervailable subsidy is a subsidy described in Article 3 or 6.1” of the WTO Agreement on Subsidies and Countervailing Measures.<sup>116</sup> Article 3 of the WTO Subsidies Agreement describes subsidies that are prohibited because they are contingent upon export performance or upon the use of domestic over imported

---

<sup>112</sup> See Import Shipment & Market Share Analysis, attached as **Exhibit I-2**.

<sup>113</sup> 19 U.S.C. § 1677(7)(F)(i)(IV).

<sup>114</sup> See Import Shipment & Market Share Analysis, attached as **Exhibit I-2**.

<sup>115</sup> See *id.*

<sup>116</sup> 19 U.S.C. § 1677(7)(F)(i)(I).

goods.<sup>117</sup> As discussed, in Volumes V, VI, and VII of these Petitions, the governments of China, Indonesia, and Vietnam provide countervailable subsidies that encourage the expansion of capacity, production, and export of the subject merchandise to the United States.<sup>118</sup>

Examples of some of the subsidies that benefit hardwood and decorative plywood producers in China, Indonesia, and Vietnam are as follows:

### China

- Export loans at preferential rates provided to hardwood and decorative plywood producers by Chinese government authorities, where receipt of the financing is contingent upon exporting;
- Grants provided to hardwood and decorative plywood producers to assist in the development of export markets or to recognized export performance;
- Preferential land use rights that are granted to promote exports to enterprises and industries located in China's industrial zones;
- Preferential income tax treatment for Chinese hardwood and decorative plywood producers whose exports constitute a certain portion of their overall sales; and
- Income tax credits for domestically owned companies, which are contingent upon the use of domestically produced rather than imported equipment.

### Indonesia

- Corporate income tax holiday for pioneer industries, including hardwood and decorative plywood producers whose projects for investment meet a minimum of IDR 500 billion;
- Provision of standing timber for less than adequate remuneration, with reduced stumpage prices for hardwood and decorative plywood producers located in specific areas including Java Province, where the majority of them are located; and

---

<sup>117</sup> *Agreement on Subsidies and Countervailing Measures* (Apr. 15, 1994), Marrakesh Agreement Establishing the World Trade Organization, Annex 1, 1867 U.N.T.S. 14 at Art. 3.

<sup>118</sup> Petition for the Imposition of Countervailing Duties, *Certain Hardwood Plywood Products from Indonesia*, vol. V (Mar. 22, 2025); Petition for the Imposition of Countervailing Duties, *Certain Hardwood Plywood from the People's Republic of China*, vol. VI (Mar. 22, 2025); Petition for the Imposition of Countervailing Duties, *Certain Hardwood Plywood from the People's Republic of Vietnam*, vol. VII (Mar. 22, 2025).

- Tax holidays and tax allowances for hardwood and decorative plywood producers located in Government of Indonesia-licensed Industrial Estates, targeted at the strategic development of Indonesia.
- Transnational subsidies from China for veneer provided for less than adequate remuneration.

### **Vietnam**

- Preferential loans to exporters by State-Owned Commercial Banks, including, for example, the State Bank of Vietnam's preferential credit package for forestry and fishery;
- Income tax preferences for Enterprises in Special Zones, including tax exemptions for 2 to 4 years or a 50 percent reduction in payable tax amounts for 6 to 7 years, depending on the projects and where they are executed; and
- Exemption from Land and Water rents for encouraged industries and selected areas, as Thang Quan Industrial Park, where Vietnamese hardwood plywood producers are located.
- Transnational subsidies from China for veneer provided for less than adequate remuneration.

**Excess Capacity and Inventories:** Information about foreign producers' inventories and excess capacity are not reasonably available to Petitioner. However, public reporting suggests foreign producers have substantial available capacity that will target the U.S. market. Just prior to the POI, the Chinese industry boasted that they had "the largest number of plywood mills in the world," at approximately 15,200 mills.<sup>119</sup> The U.S. Department of Agriculture estimates that China produces between 280 and 300 million cubic meters per year, or approximately 3 and 3.2 billion square feet.<sup>120</sup> China's State Forestry and Grassland Administration Development Planning Institute report that in 2024, there are more than 6,900 plywood manufacturers in China, with total

---

<sup>119</sup> *Import Plywood from China*, Yalong Wood (Jan. 6, 2021), attached as **Exhibit I-33**.

<sup>120</sup> *See Solid Wood 2024 Annual Report*, People's Republic of China, U.S. Dep't of Agriculture, Foreign Agricultural Service (Aug. 19, 2024), Report No. CH2024-0109, at 6, attached as **Exhibit I-34**.

production capacity of 202 million cubic meters per year.<sup>121</sup> China remains by far the world's largest exporter of plywood, accounting for 43 percent of all world exports in 2023.<sup>122</sup> And, as China's housing market continues to drastically decline, more and more Chinese producers will turn to large export markets like the United States to replace lost revenue in the Chinese market.<sup>123</sup>

Indonesian and Vietnamese producers likewise have and are adding substantial capacity to produce hardwood and decorative plywood. Vietnamese production of plywood and veneers grew 12 percent year-over-year from 2023 to 2024<sup>124</sup> and Vietnamese producers have made significant investments in increased production capacity.<sup>125</sup> For example, Sunply Co., Ltd., an export focused producer (including U.S. exports), expanded by establishing a third production factory in 2022, increasing its total yearly production capacity to 240,000 cubic meters.<sup>126</sup>

According to Indonesia's Ministry of Industry, there were approximately 107 companies that produced plywood, fancy plywood and decorative plywood in 2023.<sup>127</sup> Indonesian producers PT Wijaya Cahaya Timber TBK ("PT Wijaya"), PT Sengon Indah Mas ("PT SIM"), and Aksha Karunia Mill all reported increasing production capacity either during the POI or just prior to the POI. PT Wijaya opened a new factory near the end of 2021 with the capacity to produce 96,000

---

<sup>121</sup> See *The risk of overheated investment in particleboard is further increasing*, China Forest Products Industry (July 22, 2024), attached as **Exhibit I-35**.

<sup>122</sup> See *Solid Wood 2024 Annual Report*, People's Republic of China, U.S. Dep't of Agriculture, Foreign Agricultural Service (Aug. 19, 2024), Report No. CH2024-0109, at 13, attached as **Exhibit I-34**.

<sup>123</sup> See *id.* at 3-7.

<sup>124</sup> See *Vietnam's plywood and veneer production grows steadily in 2024*, the-shiv (Jan. 23, 2025), attached as **Exhibit I-36**.

<sup>125</sup> See, e.g., *Vinawood 3 Factory: Elevating Vietnam Plywood Industry Standards*, Vina Wood Ltd. (Apr. 3, 2024) (noting opening of new facility with production capacity of 150 containers per month), attached as **Exhibit I-37**.

<sup>126</sup> *Manufacturer*, Sunply Capacity Website Excerpt (last accessed May 6, 2025), attached as **Exhibit I-38**.

<sup>127</sup> See Arnanto Nurprabowo and Sari Rahayu, *Downstream Sector Investment Study Forest Resource Results*, BKPM (2023) at 31, excerpts attached as **Exhibit I-39**.

cubic meters (1.03 million square feet) and expanded capacity in existing factories by an additional 30,000 cubic meters.<sup>128</sup> PT SIM's company websites states that it has the capacity to produce up to 150,000 cubic meters of plywood products annually and that it "is expecting a new phase of expansion in the near future."<sup>129</sup> Both PT Wijaya and PT SIM target their exports to the United States.<sup>130</sup>

As demonstrated above, subject producers made substantial investments in adding and expanding U.S.-dedicated capacity. Moreover, given softer demand in 2023 and 2024, it is likely that many of these companies increased inventories, rather than ramping down production. These large volumes of available capacity and inventories threaten to injure the domestic industry further in the future.

## V. CONCLUSION

The statutory factors support a finding that imports of hardwood and decorative plywood from China, Indonesia, and Vietnam have caused material injury to the domestic industry, and that such imports threaten additional material injury. Accordingly, Petitioner requests that the Department and the Commission initiate investigations and grant the relief requested in these Petitions.

---

<sup>128</sup> See *About Us*, PT Cahaya Wijaya Timber Website Excerpt (last accessed May 6, 2025), attached as **Exhibit I-40**; *Initial Public Offering of Shares*, PT Wijaya Cahaya Timber TBK (Feb. 1, 2023) at 128, excerpts attached as **Exhibit I-41**.

<sup>129</sup> See *Our Factories*, PT Sengon Indah Mas Website Excerpt (last accessed May 6, 2025), attached as **Exhibit I-42**.

<sup>130</sup> See *id.*; *Initial Public Offering of Shares*, PT Wijaya Cahaya Timber TBK (Feb. 1, 2023) at 128, excerpts attached as **Exhibit I-41**.



**PUBLIC VERSION**

Respectfully submitted,

*/s/ Timothy C. Brightbill*

---

Timothy C. Brightbill, Esq.  
Stephanie M. Bell, Esq.  
Stephen A. Morrison, Esq.

**WILEY REIN LLP**  
2050 M Street, NW  
Washington, DC 20036  
(202) 719-7000

*Counsel to the Coalition for Fair Trade in  
Hardwood Plywood*

**ECONOMIC CONSULTANTS:**

Richard F. DiDonna  
Amy M. Sherman  
Carol Sayeg

**WILEY TRADE ANALYTICS GROUP**  
2050 M Street, NW  
Washington, DC 20036  
(202) 719-7000

Dated: March 22, 2025

EXHIBIT LIST		
EXHIBIT NO.	DESCRIPTION	SECURITY
I-1	Declaration of [ Name ]	Public Version
I-2	Import Shipment & Market Share Analysis	Public Version
I-3	List of Petitioners and Contact Information	Public
I-4	Non-Petitioner U.S. Hardwood Plywood Manufacturers	Public
I-5	Declaration of [ Name ]	Public Version
I-6	Petitioner's Trade and Financial Data	Public Version
I-7	<i>How is Plywood Made?</i> , Curtis Lumber & Plywood (July 11, 2019)	Public
I-8	American Nat'l Standard Inst., <i>ANSI/HPVA HP-1 2024</i> , American Nat'l Standard for Hardwood and Decorative Plywood (approved Aug. 20, 2024)	Public
I-9	<i>Veneer Cuts and Matching</i> , Columbia Forest Products Website Excerpt (last accessed May 1, 2025)	Public
I-10	David Mercker, <i>Quality Hardwood Veneer</i> , University of Tennessee Agricultural Extension Service (May 2004)	Public
I-11	<i>Plywood Production Process</i> , Yalong Wood (Jan. 19, 2021)	Public
I-12	Harmonized Tariff Schedule of the United States Revision 13, Ch. 44, 94(2025) (excerpts)	Public
I-13	Letter from U.S. Customs and Border Protection to InterGlobal Forest, Inc., et. al., re: <i>Notice of Initiation of Investigation and Interim Measures – APA Cons. Case 7321</i> (Oct. 1, 2019)	Public

EXHIBIT LIST		
EXHIBIT NO.	DESCRIPTION	SECURITY
I-14	Memorandum from Kristina Horgan, Chief, EAPA Invs. Branch, to Africa Bell, Acting Dir., Enf't Operations Div., re: <i>Initiation of Investigation for EAPA Case Number 7323 – American Pacific Plywood</i> (June 26, 2019)	Public
I-15	Memorandum from Kristina Horgan, Chief, EAPA Invs. Branch, to Africa Bell, Acting Dir., Enf't Operations Div., re: <i>Initiation of Investigation for EAPA Case Number 7327 – U.S. Global Forest, Inc.</i> (June 26, 2019)	Public
I-16	List of Known Foreign Producers	Public
I-17	List of Known U.S. Importers	Public
I-18	Lost Sales and Lost Revenues	Public Version
I-19	Declaration of [ Name ]	Public Version
I-20	Emails Discussing Pine-Faced Decorative Plywood	Public Version
I-21	<i>Manufacturing Locations</i> , Columbia Forest Products Website Excerpt (last accessed May 1, 2025)	Public
I-22	<i>Columbia Forest Products</i> , Home Depot Website Excerpt (last accessed May 1, 2025)	Public
I-23	Subject Imports by Region	Public
I-24	Subject Imports by Month	Public
I-25	Negligibility Analysis	Public
I-26	<i>Single-Family Starts Down in December but Post Solid Showing</i> , National Association of Home Builders (Jan. 18, 2024)	Public

EXHIBIT LIST		
EXHIBIT NO.	DESCRIPTION	SECURITY
I-27	Sarah Hansen, <i>Is the US Headed for a Recession? What Analysts Are Saying About Q1's GDP Decline</i> , Morningstar (Apr. 30, 2025)	Public
I-28	Lauren Aratani, <i>U.S. economy shrinks in first quarter of Trump 2.0 amid sweeping tariffs</i> , The Guardian (Apr. 30, 2025)	Public
I-29	<i>The probability of a recession remains at 60%</i> , J.P. Morgan (Apr. 15, 2025)	Public
I-30	Paul Davidson, <i>Economy will likely slow to near standstill or recession despite Trump tariff pause: Survey</i> , USA Today (Apr. 14, 2025)	Public
I-31	<i>Roseburg Forest Products Lays Off 2.5% of Its North American Workforce</i> , ForestNet (Dec. 20, 2024)	Public
I-32	<i>Besse Closing 3 Hardwood Veneer/Plywood Plants in Wisconsin</i> , Building Products Digest (Aug. 6, 2024)	Public
I-33	<i>Import Plywood from China</i> , Yalong Wood (Jan. 6, 2021)	Public
I-34	<i>Solid Wood 2024 Annual Report</i> , People's Republic of China, U.S. Dep't of Agriculture, Foreign Agricultural Service (Aug. 19, 2024), Report No. CH2024-0109	Public
I-35	<i>The risk of overheated investment in particleboard is further increasing</i> , China Forest Products Industry (July 22, 2024)	Public
I-36	<i>Vietnam's plywood and veneer production grows steadily in 2024</i> , the-shiv (Jan. 23, 2025)	Public
I-37	<i>Vinawood 3 Factory: Elevating Vietnam Plywood Industry Standards</i> , Vina Wood Ltd. (Apr. 3, 2024)	Public

<b>EXHIBIT LIST</b>		
<b>EXHIBIT NO.</b>	<b>DESCRIPTION</b>	<b>SECURITY</b>
I-38	<i>Manufacturer</i> , Sunply Capacity Website Excerpt (last accessed May 6, 2025)	Public
I-39	Arnanto Nurprabowo and Sari Rahayu, <i>Downstream Sector Investment Study Forest Resource Results</i> , BKPM (2023) (excerpts)	Public
I-40	<i>About Us</i> , PT Cahaya Wijaya Timber Website Excerpt (last accessed May 6, 2025)	Public
I-41	<i>Initial Public Offering of Shares</i> , PT Wijaya Cahaya Timber TBK (Feb. 1, 2023) (excerpts)	Public
I-42	<i>Our Factories</i> , PT Sengon Indah Mas Website Excerpt (last accessed May 6, 2025)	Public

# EXHIBIT I-1

**DECLARATION**

I, [ name ], declare and state as follows:

1. I am currently employed as [ title ] and have worked in the domestic hardwood and decorative plywood industry for more than [ # ] years. Prior to becoming [ employment history ] in the United States. Based on my experience in the domestic hardwood and decorative plywood industry, I have extensive knowledge regarding the U.S. hardwood and decorative (including softwood/pine faced panels) plywood market, including an in-depth understanding of purchasing patterns, costing, pricing, and sales in the United States. I have also worked on trade issues involving hardwood and decorative (including softwood/pine faced panels) plywood, including monitoring trade flows of traded hardwood plywood panels from China, Indonesia, and Vietnam into the U.S. market.
2. The domestic hardwood and decorative plywood industry has long faced unfair competition from unfairly traded imports. Initially, the surge of unfairly traded hardwood plywood came from China. To combat these imports, the domestic industry petitioned the U.S. Department of Commerce and U.S. International Trade Commission to initiate investigations into dumped and subsidized imports of hardwood plywood from China. These investigations ultimately culminated in antidumping and countervailing duty (AD/CVD) orders being placed on imports of hardwood plywood from China in 2018.
3. Following the filing of the petitions on hardwood plywood from China, the domestic industry began to see a massive shift in import. First, Chinese producers and exporters quickly began shifting their production from plywood panels with hardwood (e.g., birch)

face/back veneers to panels with pine (a softwood) face/back veneers. These products, which had previously not been in the U.S. market, were being offered by Chinese producers/exporters as a direct substitute for hardwood plywood in order to avoid the AD/CVD investigations and ultimate duties.

4. Second, imports of hardwood and decorative (including softwood/pine faced panels) plywood from Indonesia and Vietnam began surging into the market. Immediately following the imposition of the AD/CVD orders on hardwood plywood from China, there was a massive surge in imports of hardwood and decorative plywood from these countries, including the same type of hardwood and decorative plywood that China had imported prior to the imposition of the AD/CVD orders. Indeed, in 2017, the year prior to the imposition of the AD/CVD orders on China, Indonesian and Vietnamese imports of hardwood plywood totaled only approximately 66 million square feet.<sup>1</sup> The following year, Indonesian and Vietnamese imports had grown to almost 600 million square feet.<sup>2</sup>
5. Imports of hardwood and decorative (including softwood/pine faced panels) plywood from China, Indonesia, and Vietnam continue to maintain significant presence in the U.S. market and compete with U.S. produced product on a daily basis.
6. Hardwood and decorative (including softwood/pine faced panels) plywood is sold in the United States based upon a number of factors including the thickness of the product, the number of plies (layers) in the product, the wood species used on the front and back faces of the product, the type of material used on the interior plies of the product (*e.g.*, hardwood, softwood, particle board; medium-density fiberboard (MDF)), the grade and finish of the

---

<sup>1</sup> See *Hardwood Plywood from China*, Inv. Nos. 701-TA-565 and 731-TA-1341, U.S. ITC Pub. 5426 (May 2023) (Review) at I-21 (Table I-6).

<sup>2</sup> *Id.*



surface of the outside faces of the product, the type of adhesive material used to bond the plies to each other as well as whether the product has been certified as meeting California Air Resources Board (CARB) and/or Toxic Substances Control Act (TSCA) standards relating to the existence of formaldehyde emissions in the product, and the level of finishing imparted to the front and rear faces.

- 7. Imports of hardwood and decorative plywood goods from China, Indonesia, and Vietnam are typically sold with the above factors in mind. Chinese, Indonesian, and Vietnamese imports compete with U.S.-produced hardwood and decorative plywood across a wide range of price and quality levels and for practically every application. This is true for all grades and for all major species of wood, including birch, maple, oak, walnut, tropical, cherry, and other species.
- 8. I declare under penalty of perjury under the laws of the United States that, to the best of my knowledge, the foregoing is true and correct.

Executed May 20<sup>th</sup>, 2025 in [ ]

[ ]

Signature

# EXHIBIT I-2

U.S. Imports & Market Share

Item	Calendar Year			Jan-Mar	
	2022	2023	2024	2024	2025
<b>Quantity (1,000 sq ft)</b>					
Imports from:					
Indonesia	942,688	603,023	729,663	163,695	295,329
Vietnam, subject	792,509	431,150	637,841	206,162	196,533
China, subject	66,389	99,495	134,910	32,629	38,603
Subtotal, subject	1,801,586	1,133,667	1,502,414	402,487	530,465
	24,511	13,335	19,727	6,376	6,078
	44,497	25,905	23,163	4,230	5,947
All other sources	1,879,666	1,907,288	1,631,048	416,040	400,276
Subtotal, nonsubject	1,924,163	1,933,193	1,654,211	420,271	406,223
Total imports	3,725,749	3,066,860	3,156,625	822,757	936,688
Petitioner's shipments	[				
U.S. producers' shipments	[				
Apparent U.S. consumption	[				
<b>Value (\$1,000)</b>					
Imports from:					
Indonesia	\$680,632	\$282,500	\$337,588	\$76,930	\$105,522
Vietnam, subject	\$400,724	\$185,999	\$244,073	\$67,431	\$73,152
China, subject	\$34,120	\$38,262	\$43,210	\$10,298	\$12,774
Subtotal, subject	\$1,115,476	\$506,761	\$624,870	\$154,659	\$191,449
Vietnam, nonsubject	\$12,394	\$5,753	\$7,549	\$2,086	\$2,262
China, nonsubject	\$21,040	\$11,795	\$9,709	\$1,969	\$2,221
All other sources	\$1,267,719	\$831,877	\$889,774	\$210,574	\$216,665
Subtotal, nonsubject	\$1,288,759	\$843,673	\$899,483	\$212,543	\$218,886
Total imports	\$2,404,235	\$1,350,434	\$1,524,354	\$367,203	\$410,335
Petitioner's shipments	[				
U.S. producers' shipments	[				
Apparent U.S. consumption	[				
<b>Unit Value (\$/sq ft)</b>					
Imports from:					
Indonesia	\$0.72	\$0.47	\$0.46	\$0.47	\$0.36
Vietnam, subject	\$0.51	\$0.43	\$0.38	\$0.33	\$0.37
China, subject	\$0.51	\$0.38	\$0.32	\$0.32	\$0.33
Subtotal, subject	\$0.62	\$0.45	\$0.42	\$0.38	\$0.36
Vietnam, nonsubject	\$0.51	\$0.43	\$0.38	\$0.33	\$0.37
China, nonsubject	\$0.47	\$0.46	\$0.42	\$0.47	\$0.37
All other sources	\$0.67	\$0.44	\$0.55	\$0.51	\$0.54
Subtotal, nonsubject	\$0.67	\$0.44	\$0.54	\$0.51	\$0.54
Total imports	\$0.65	\$0.44	\$0.48	\$0.45	\$0.44
U.S. producers' shipments	[				
<b>Share of quantity</b>					
Imports from:					
Indonesia	[				
Vietnam, subject	[				
China, subject	[				
Subtotal, subject	[				
Vietnam, nonsubject	[				
China, nonsubject	[	0.9			
All other sources	[				
Subtotal, nonsubject	[				
Total imports	[				
U.S. producers' shipments	[				
<b>Share of value</b>					
Imports from:					
Indonesia	[				
Vietnam, subject	[				
China, subject	[				
Subtotal, subject	[				
Vietnam, nonsubject	[			0.3	
China, nonsubject	[				
All other sources	[				
Subtotal, nonsubject	[				
Total imports	[				
U.S. producers' shipments	[				

Period Change			
2022-24	2022-23	2023-24	Q1 '24 - Q1 '25
<b>Percent</b>			
(22.6)	(36.0)	21.0	80.4
(19.5)	(45.6)	47.9	(4.7)
103.2	49.9	35.6	18.3
(16.6)	(37.1)	32.5	31.8
(19.5)	(45.6)	47.9	(4.7)
(47.9)	(41.8)	(10.6)	40.6
(13.2)	1.5	(14.5)	(3.8)
(14.0)	0.5	(14.4)	(3.3)
(15.3)	(17.7)	2.9	13.8
<b>Percent</b>			
(50.4)	(58.5)	19.5	37.2
(39.1)	(53.6)	31.2	8.5
26.6	12.1	12.9	24.1
(44.0)	(54.6)	23.3	23.8
(39.1)	(53.6)	31.2	8.5
(53.9)	(43.9)	(17.7)	12.8
(29.8)	(34.4)	7.0	2.9
(30.2)	(34.5)	6.6	3.0
(36.6)	(43.8)	12.9	11.7
<b>Percent</b>			
(35.9)	(35.1)	(1.2)	(24.0)
(24.3)	(14.7)	(11.3)	13.8
(37.7)	(25.2)	(16.7)	4.9
(32.8)	(27.8)	(7.0)	(6.1)
(24.3)	(14.7)	(11.3)	13.8
(11.3)	(3.7)	(7.9)	(19.8)
(19.1)	(35.3)	25.1	6.9
(18.8)	(34.8)	24.6	6.5
(25.2)	(31.8)	9.7	(1.8)
<b>Percentage Points</b>			
(2.5)			
		0.8	
<b>Percentage Points</b>			
			0.0
(0.2)			

Source: USITC Dataweb & US Shipment data from:  
 Columbia  
 Commonwealth  
 Manthei  
 States  
 Timber

# EXHIBIT I-3

**Members of the Coalition of Fair Trade of Hardwood Plywood**

1. **Columbia Forest Products**  
7900 McCloud Road  
Suite 200  
Greensboro, NC 27409  
Phone: (800) 637-1609  
Contact Person: Greg Pray  
Email: gpray@cfpwood.com
  
2. **Commonwealth Plywood Co., Ltd.**  
P.O. Box 30  
Whitehall, NY 12887  
Phone: (518) 499-0099  
Contact Person: Bill Caine  
Email: wtcaine@commonwealthplywood.com
  
3. **Manthei Wood Products**  
3996 US 31 South  
Petoskey, MI 49770  
Phone: (231) 347-7040  
Contact Person: Jeremy Manthei  
Email: jeremy@mantheiwoodproducts.com
  
4. **States Industries LLC**  
P.O. Box 41150  
Eugene, OR 97404  
Phone: (800) 626-1981  
Contact Person: Mike Taylor  
Email: mtaylor@statesind.com
  
5. **Timber Products Company**  
P.O. Box 269  
305 South 4<sup>th</sup> Street  
Springfield, OR 97477-0055  
Phone: (541) 744-4252  
Contact Person: Jeff Gregory  
Email: jgregory@timberproducts.com

# EXHIBIT I-4

### Other U.S. Producers of Hardwood Plywood

1. Cahaba Veneer & Plywood, Inc.

P.O. Box 98  
324 Mill St.  
Centreville, AL 35042

Contact: Pete Browder  
Ph: 205-926-9797  
Email: [Pete@cahabaveneer.com](mailto:Pete@cahabaveneer.com)

2. Chesterfield Wood Products Inc.

P.O. Box 1792  
Morgantown, NC 28680

Contact: M. Todd Powell  
Ph: 828-433-0042  
Email: [bvi1981@att.net](mailto:bvi1981@att.net)

3. Darlington Veneer Co., Inc.

P.O. Box 1087  
Darlington, SC 29540

Contact: Rich Smothers  
Ph: 843-393-3861  
Email: [rsmothers@darlingtonveneer.com](mailto:rsmothers@darlingtonveneer.com)

4. Eastern Panel Manufacturing Inc.

100 My Twinn Lane  
Chatham, VA 24531

Contact: Keith Van Asch  
Ph: 434-432-3055  
Email: [keith@easternpanel.com](mailto:keith@easternpanel.com)

5. GL Veneer Co., Inc.  
2224 E. Slauson Ave.  
Huntington Park, CA 90255

Contact: Jeffrey Levin  
Ph: 323-582-5203  
Email: [sales@glveneer.com](mailto:sales@glveneer.com)

6. Great Lakes Veneer  
P.O. Box 476  
Marion, WI 54950-0476

Contact: Nick Rogers  
Ph: 715-754-2501  
Email: [nrogers@greatlakesveneer.com](mailto:nrogers@greatlakesveneer.com)

7. Laminate Technologies  
161 Maule Road  
Tiffin, OH 44883

Contact:  
Ph: 419-448-0812  
Email: [sales@lamtech.net](mailto:sales@lamtech.net)

8. Murphy Company  
2350 Prairie Rd.  
Eugene, OR 97402

Contact: John Murphy Jr.  
Ph: 541-461-4545  
Email: [sales@murphyplywood.com](mailto:sales@murphyplywood.com)

9. Roseburg Forest Products Co.  
3660 Gateway Street  
Springfield, OR 97477

Contact: Ryan Phillips  
Ph: 800-859-6998  
Email: [ryanp@rfpco.com](mailto:ryanp@rfpco.com)



10. S.J. Morse Company  
2736 Northwestern Pike  
P.O. Box 600  
Capon Bridge, WV 26711

Contact: Nathan Hite  
Ph: 304-856-3423  
Email: [infor@sjmorse.com](mailto:infor@sjmorse.com)

11. The Wood Gallery, Inc.  
10724 Goodnight Lande  
Dallas, TX 75220-2409

Contact: Barrett Lee  
Ph: 972-869-9161  
Email: [barrett@woodgallery.biz](mailto:barrett@woodgallery.biz)

# EXHIBIT I-5

**DECLARATION**

I, [ Name ], declare and state as follows:

1. I am currently employed as [ title ], a role in which I have served for [ # ] years. In my [ ], I have maintained extensive knowledge regarding the U.S. hardwood and decorative plywood industry, including U.S. production data.

2. The [ description of job ]. Accordingly, [ name ] collects significant amounts of data about the hardwood and decorative plywood industry, including annual hardwood and decorative plywood production data.

3. [ Narrative describing reporting

].

4. [ Explanation of reporting

].

5. Based on this data, the estimated annual production of hardwood and decorative plywood in the United States in 2024 was [ # ] square feet.

6. Although responses to the [ Explanation of reporting ]  
].

7. The text surrounded by brackets contains business proprietary information, the release of which would cause serious commercial harm to the submitter.

8. I declare under penalty of perjury under the laws of the United States that, to the best of my knowledge, the foregoing is true and correct.

Executed May 20, 2025 in [ Location ]

[ Signature ]  
\_\_\_\_\_ ]  
[ ]





# EXHIBIT I-6

**ENTIRE EXHIBIT  
NOT CAPABLE OF  
PUBLIC SUMMARY**

# EXHIBIT I-7

# How is Plywood Made? Curtis Lumber & Plywood [\(https://clp-inc.com/\)](https://clp-inc.com/)

July 11, 2019 | by [Curtis Lumber & Plywood \(https://clp-inc.com/author/curtis-lumber/\)](https://clp-inc.com/author/curtis-lumber/)

 Share  Share  Share  Share  Share

Plywood is incredibly useful, with practical applications that include interior, structural, and exterior projects. It can be used to complete jobs that range from formwork all the way to paneling. But just what is plywood, and how is it made? In this post, we will answer these questions and learn more about why plywood is such a versatile material for outdoor and indoor construction projects alike.

## What Is Plywood?

Plywood is a material (wood) manufactured from thin layers or “plies” of wood veneer that are glued together with adjacent layers having their wood grain rotated up to 90 degrees to one another. In the most basic of terms, plywood is made by combining wood veneers together in order to create a flat sheet.

## Process

Plywood pieces are formed differently depending on their intended use. For example, if the plywood is to be used for building purposes, it is pressed into flat large sheets. If it is intended to be used in aircraft or boat construction or to build furniture, it is formed into curves. Every layer of ply has its grain running in right angles. This helps to keep the layer strong and durable while also limiting any chance of it shrinking. The plywood itself is constructed of a minimum of three layers of wood that are held together using an adhesive.

The two outside areas of the plywood are called the back and the face. The back is typically the part that is hidden from view while the face is the one that can be viewed. The layer in the middle is referred to as the core and if there are five or more plies used, the additional internal layers are considered crossbands.



## Materials



Determining how plywood is made depends a great deal on the materials used. Plywood can be made from softwoods or hardwoods. It can also be constructed of a mix of the two. Some common softwoods used to create plywood include cedar, pine, redwood and spruce but the most commonly used is Douglas fir. For hardwoods, plywood is commonly created using oak, mahogany, teak, maple or ash. If using composite plywood, the core will be made of either solid lumber pieces or particle board. Composite plywood is typically used when the project calls for very thick sheets.

There are various types of adhesive that can be used to combine the layers of wood to create a sheet of plywood. The type used depends on the usage for the plywood. For example, a phenol-formaldehyde resin will be used if the sheets are to be used for a structure's exterior. That is because the adhesive is very strong and will resist any damage caused by moisture, an important feature for any outdoor project.

If the plywood is to be used for the interior of a structure, the adhesive used is usually either made from a soybean protein or a blood protein. However, many of these interior plywood sheets will now often use the same phenol-formaldehyde resin that is used for exterior sheets. Finally, if the plywood is to be used for building furniture, the adhesive is usually made with a urea-formaldehyde resin.

There are other materials that can also be used in the construction of plywood. For example, some projects require that a layer of metal, plastic, paper or fabric be bonded to the back or face, or sometimes both, of the plywood. This helps to make the sheet even more resistant to moisture. That plywood is referred to as overlaid plywood and is most often used in the transportation, agricultural and construction industries.

Plywood can also have a layer of liquid stain used to give it a more polished look, which is used for more decorative projects. Finally, plywood can be treated with a variety of different chemicals to promote different properties. For example, it can be treated to be more resistant to flames or decay.

## Classification



**Curtis Lumber  
& Plywood**

[\(https://clp-inc.com/\)](https://clp-inc.com/)

In general, there are two classifications of plywood, both of which have their own grading system. The two classes are construction/industrial and hardwood/decorative. Those plywoods that are included in the construction/industrial classification are used for their strength. They are rated depending on the grade of veneer that is used on their back and face as well as their exposure capability. That exposure capability can be either exterior or interior and usually depends on the type of adhesive used. The grades of veneer in this classification can be D, C, B, A, or N. The D grade is the lowest with multiple defects while the N grade has very few defects. As a rule of thumb, plywood that is used for subflooring usually has a rating of C to D.

The second classification of plywood, hardwood/decorative, is used for its overall attractive appearance. The grading in this class is dependent upon the plywood's ability to resist moisture. The face of this plywood is almost always free from defects, at least by the naked eye, given that it is used for its decorative purposes. The gradings are Type III, Type II, Type I, and Technical.

## Sizes

Plywood can range quite substantially in size. The thickness can be anywhere from 0.6 inches all the way to 3 inches, with the most commonly used being somewhere in the range of 0.25 to 0.75 inches thick. The back and face of any veneer must have the same thickness and the top and bottom crossbands must also be of the same size.

Given the universal properties of plywood, it can be used in virtually any building or decorative project. If you need more information or are still wondering how is plywood made, reach out to Curtis Lumber & Plywood for more information.



7351 Highland St.  
Springfield, VA 22150  
[\(703\) 552-5778 \(tel:+17035525778\)](tel:+17035525778)

## Treated Products (/treated-products/)

- > [CCA \(https://clp-inc.com/treated-products/cca-plywood/\)](https://clp-inc.com/treated-products/cca-plywood/)
- > [Copper Azole \(https://clp-inc.com/treated-products/copper-azole-lumber/\)](https://clp-inc.com/treated-products/copper-azole-lumber/)
- > [Micro-Guard™ \(https://clp-inc.com/treated-products/micro-guard/\)](https://clp-inc.com/treated-products/micro-guard/)
- > [Exterior Fire-X™ \(https://clp-inc.com/treated-products/exterior-fire-x/\)](https://clp-inc.com/treated-products/exterior-fire-x/)
- > [Pyro-Guard® \(https://clp-inc.com/treated-products/pyro-guard/\)](https://clp-inc.com/treated-products/pyro-guard/)

## Plywood (/plywood/)

- > [ACX \(https://clp-inc.com/plywood/acx/\)](https://clp-inc.com/plywood/acx/)
- > [Marine Grade \(https://clp-inc.com/plywood/marine-grade/\)](https://clp-inc.com/plywood/marine-grade/)
- > [Medium Density \(https://clp-inc.com/plywood/mdo/\)](https://clp-inc.com/plywood/mdo/)
- > [Southern Yellow Pine \(https://clp-inc.com/plywood/southern-yellow-pine/\)](https://clp-inc.com/plywood/southern-yellow-pine/)

© 2025 [Curtis Lumber and Plywood, Inc. \(/\)](#) · Powered by [321 Web Marketing \(https://321webmarketing.com/\)](https://321webmarketing.com/) ·  
Website [Privacy Policy \(/privacy-policy/\)](#) & [Terms of Use \(/terms-of-use/\)](#)

# EXHIBIT I-8

ANSI/HPVA

HP-1-2024

APPROVED AUGUST 20, 2024

# AMERICAN NATIONAL STANDARD

## FOR HARDWOOD AND DECORATIVE PLYWOOD



American National Standards Institute  
[www.ansi.org](http://www.ansi.org)

Consensus Standards Organization



Hardwood Plywood & Veneer Association®  
[www.decorativehardwoods.org](http://www.decorativehardwoods.org)

ANSI Accredited Standards Developer



Canadian Hardwood Plywood & Veneer Association  
[www.chpva.ca](http://www.chpva.ca)

Adopted By



Western Hardwood Plywood Producers

Adopted By

# American National Standard For Hardwood and Decorative Plywood

## ABSTRACT

This American National Standard for Hardwood and Decorative Plywood establishes nationally recognized marketing classifications, quality criteria, test methods, definitions, and product marking and designation practices for plywood produced primarily from hardwoods. It is intended for voluntary use for reference in trade literature, catalogs, sales contracts, building codes, government regulations and standards of performance, and procurement specifications to describe the quality aspects of the product and the means to determine conformance.

Requirements are given for wood species, veneer face grades, back grades, inner ply grades, medium density fiberboard (MDF) core, lumber core, particleboard core, hardboard core, bond line performance, updated and revised formaldehyde emissions, panel constructions, dimensions, moisture content, sanding, and finishing. Sampling and testing provisions cover dry and cyclic-boil shear, cyclic cold soak test methods for bond line performance determinations, and field and laboratory moisture content measuring methods. A glossary of trade terms is provided for better communication and understanding, and provisions are made for panel marking to indicate compliance with this Standard. Any "Note" appearing in this Standard is explanatory in nature and not mandatory.

Key words: Decorative plywood; hardwood plywood; plywood, hardwood and decorative; veneer grades; decorative softwood and hardwood; and formaldehyde emission requirements.

## THE METRIC SYSTEM OF MEASUREMENT

The 1975 Metric Conversion Act, as amended by the Omnibus Trade and Competitiveness Act of 1988, sets forth that the metric (SI) is the preferred system of measurement in the U.S. The publication of this Standard provides a unique opportunity to examine the metric system for a product that is predominately used in North America (less than 10% U.S. production is exported). This document contains metric units first with English (inch-pound) units in parentheses. The metric number in almost all cases is the "soft" conversion number for the accepted inch-pound system requirement. In order to make the metric number more conceptually coherent and for consistency, most conversions for less than 76 mm (3 inches) in dimension are "soft" converted to the nearest 0.1 mm. For measurements above 76 mm (3 inches), the "soft" value is converted to the nearest 1 mm.

Tables have presented a special challenge in presenting both metric and inch-pound numbers. In those cases where a limited number of conversions are necessary, both metric and inch-pound numbers appear. In other cases, two full and separate tables are provided, arranged to face each other on adjacent pages. In such cases, these tables are designated "Metric" or "Inch-Pound."

## TABLE OF CONTENTS

FOREWORD .....	iv	TABLE 3.1b – SUMMARY OF HARDWOOD FACE GRADE CHARACTERISTICS – Ash, Beech, <sup>b</sup> Birch, Maple and Poplar .....	12
1. PURPOSE AND INTENDED USE .....	1	TABLE 3.2b – SUMMARY OF HARDWOOD FACE GRADE CHARACTERISTICS – Mahogany, Anegre, Makore, Sapele and other veneers with similar characteristics.....	13
1.1 PURPOSE .....	1	TABLE 3.3b – SUMMARY OF HARDWOOD FACE GRADE CHARACTERISTICS – Red and White Oak.....	14
1.2 INTENDED USE .....	1	TABLE 3.4b – SUMMARY OF HARDWOOD FACE GRADE CHARACTERISTICS – Pecan and Hickory .....	15
2. SCOPE AND CLASSIFICATION .....	1	TABLE 3.5b – SUMMARY OF HARDWOOD FACE GRADE CHARACTERISTICS – Walnut and Cherry .....	16
2.1 SCOPE .....	1	TABLE 4 – HARDWOOD DOOR FACE GRADE CHARACTERISTICS .....	17
2.2 CLASSIFICATION .....	1	TABLE 5 – SUMMARY OF HARDWOOD FACE AND BACK GRADE CHARACTERISTICS – Western Red Alder.....	18
2.2.1 COMMERCIAL SPECIES AND COMMERCIAL SPECIES GROUPS .....	1	TABLE 6 – SUMMARY OF DECORATIVE SOFTWOOD GRADE CHARACTERISTICS .....	19
2.2.2 GRADES OF VENEERS .....	1	3.3.6 GRADE D.....	20
2.2.3 TYPES OF PLYWOOD.....	2	3.3.7 GRADE E .....	20
2.2.4 CONSTRUCTIONS.....	2	3.3.8 RUSTIC GRADE (R) .....	20
2.2.5 SIZES AND THICKNESSES .....	2	3.3.9 SPECIALTY GRADE (SP) .....	20
2.2.6 PANEL PERFORMANCE PROPERTIES .....	2	3.3.10 SOFTWOOD GRADES .....	20
TABLE 1 – A COMPARISON OF THE PHYSICAL PROPERTIES OF SOME POPULAR SPECIES IN LUMBER FORM .....	3	3.3.11 RECONSTITUTED VENEER .....	20
3. REQUIREMENTS.....	4	3.4 BACK GRADES .....	20
3.1 GENERAL .....	4	3.5 INNER PLY GRADES.....	20
3.1.1 LEGALLY LOGGED WOOD.....	4	3.6 THICKNESS OF VENEERS .....	20
3.2 SPECIES FOR FACES, BACKS, AND INNER PLIES .....	4	3.7 LUMBER CORES.....	21
3.3 FACE GRADE DESCRIPTIONS.....	4	3.7.1 CLEAR GRADE.....	21
FIGURE 1 – FACE MATCHING.....	4	3.7.2 SOUND GRADE.....	21
3.3.1 FACE APPEARANCE – GENERAL .....	4	3.7.3 REGULAR GRADE.....	21
TABLE 2 – COMMON FACE VENEER PATTERNS FOR SELECTED COMMERCIAL SPECIES.....	5	3.7.4 CLEAR EDGE.....	21
3.3.2 GRADE AA .....	6	3.7.5 BANDED CORE .....	21
3.3.3 GRADE A .....	6	3.8 PARTICLEBOARD (PB), FIBERBOARD (MDF), ORIENTED STRAND BOARD (OSB) AND HARDBOARD CORES .....	21
3.3.4 GRADE B.....	6	3.9 SPECIAL CORES .....	21
3.3.5 GRADE C.....	6	3.10 CONSTRUCTION .....	21
TABLE 3.1a – SUMMARY OF HARDWOOD FACE GRADE CHARACTERISTICS – Ash, Beech, <sup>b</sup> Birch, Maple and Poplar.....	7	3.10.1 SPECIAL CONSTRUCTION.....	21
TABLE 3.2a – SUMMARY OF HARDWOOD FACE GRADE CHARACTERISTICS – Mahogany, Anegre, Makore, Sapele and other veneers with similar characteristics .....	8	TABLE 7 – SUMMARY OF ALLOWABLE NATURAL CHARACTERISTICS FOR BACK GRADES.....	22
TABLE 3.3a – SUMMARY OF HARDWOOD FACE GRADE CHARACTERISTICS – Red and White Oak .....	9	TABLE 8 – SUMMARY OF ALLOWABLE OPENINGS FOR INNER PLY GRADES OF CORE VENEER <sup>a</sup> .....	23
TABLE 3.4a – SUMMARY OF HARDWOOD FACE GRADE CHARACTERISTICS – Pecan and Hickory.....	10	FIGURE 2 – TYPICAL PLYWOOD CONSTRUCTIONS AND PROPERTIES COMPARISON* .....	24
TABLE 3.5a – SUMMARY OF HARDWOOD FACE GRADE CHARACTERISTICS – Walnut and Cherry.....	11	TABLE 9a – LIMITING CRITERIA FOR PLYWOOD.....	25

TABLE 9b – PERFORMANCE CRITERIA FOR PLYWOOD .....	26
TABLE 10 – WOOD FAILURE REQUIREMENTS FOR TECHNICAL AND TYPE I PLYWOOD BOND LINES.....	27
3.11 BOND LINE AND RELATED REQUIREMENTS .	27
3.11.1 CONSTRUCTION REQUIREMENTS.....	27
3.11.2 TECHNICAL & TYPE I PLYWOOD .....	27
3.11.3 TYPE II PLYWOOD .....	27
3.12 FORMALDEHYDE EMISSIONS.....	27
3.13 DIMENSIONS AND TOLERANCES.....	27
3.13.1 SQUARENESS .....	28
3.13.2 STRAIGHTNESS .....	28
3.14 SANDING.....	28
3.15 MOISTURE CONTENT.....	28
3.16 FINISHED PANELS.....	28
3.16.1 GENERAL .....	28
3.16.2 FINISH PERFORMANCE.....	28
3.17 PRODUCT MARKING AND DESIGNATION.....	28
3.17.1 GENERAL .....	28
3.17.1.1 TOLERANCES .....	28
3.17.2 IDENTIFICATION OF COMPLIANCE .....	28
3.17.3 IDENTIFICATION OF THIRD-PARTY CERTIFICATION.....	29
3.17.3.1 CERTIFIED MARK.....	29
4. INSPECTION AND TEST PROCEDURES .....	29
4.1 GENERAL .....	29
4.2 SPECIMENS FOR BOND LINE TESTS .....	29
4.2.1 TECHNICAL AND TYPE I PLYWOOD.....	29
4.2.2 TYPE II PLYWOOD .....	29
TABLE 11 – TEST SPECIMEN SIZES .....	30
4.3 DRY SHEAR TEST.....	30
4.4 CYCLIC-BOIL SHEAR TEST .....	30
4.5 TWO-CYCLE BOIL TEST .....	30
4.6 THREE-CYCLE SOAK TEST .....	30
4.7 MOISTURE CONTENT TEST .....	31
FIGURE 3 – PLYWOOD BOND SHEAR SPECIMENS ....	32
5. DEFINITIONS.....	33
6. IDENTIFICATION.....	37
APPENDIX A.....	38
APPENDIX B.....	40



## FOREWORD

(This Foreword is not part of the American National Standard for Hardwood and Decorative Plywood, ANSI/HPVA HP-1-2024.)

This Voluntary Standard supersedes the American National Standard for Hardwood and Decorative Plywood, ANSI/HPVA HP-1-2020, a standard sponsored by the Hardwood Plywood & Veneer Association® (HPVA®), DBA Decorative Hardwoods Association (DHA), and developed under the HPVA® Policy for the Development and Maintenance of Voluntary American National Standards.

In April 1931, the commercial standard for hardwood plywood was established and published as Commercial Standard CS35-31 by the Commodity Standards Division, National Bureau of Standards, U.S. Department of Commerce. The standard was revised in 1942, 1947, 1961, and 1971 which was designated PS-52-71. In 1983, the standard became an ANSI standard which was subsequently revised in 1992, 1993, 1994, 2000, 2004, 2016, 2020, and the current ANSI/HPVA HP-1-2024.

Suggestions for improvement gained in the use of this Standard are welcome. They should be sent to the American National Standards Institute.

Consensus for this Standard was achieved by use of the “ANSI Essential Requirements: Due process requirements for American National Standards” and the ANSI-accredited “Hardwood Plywood and Veneer Association Policy for the Development and Maintenance of Voluntary American National Standards.” The following organizations, recognized as having an interest in hardwood and decorative plywood, were contacted prior to the approval of this Standard. Inclusion in this list does not necessarily imply that the organization concurred with the proposed Standard as submitted to ANSI.

<b>Architectural Woodwork Institute (AWI)</b>	<b>Hexion</b>
<b>Business and Institutional Furniture Manufacturers Association (BIFMA)</b>	<b>Kitchen Cabinet Manufacturers Association (KCMA)</b>
<b>Canadian Hardwood Plywood and Veneer Association (CHPVA)</b>	<b>Murphy Plywood</b>
<b>Columbia Forest Products</b>	<b>National Wood Flooring Association (NWFA)</b>
<b>Composite Panel Association (CPA)</b>	<b>Roddis Lumber and Veneer Co.</b>
<b>Franklin International</b>	<b>States Industries</b>
<b>Gail Overgard, Independent</b>	<b>Timber Products</b>

Published by:

Hardwood Plywood & Veneer Association, DBA Decorative Hardwoods Association

42777 Trade West Drive

Sterling, VA 20166

Telephone: (703) 435-2900 Fax: (703) 435-2537

Website: [www.decorativehardwoods.org](http://www.decorativehardwoods.org)

Copyright© 2024 Hardwood Plywood & Veneer Association®

No part of this publication may be reproduced in any form, in an electronic retrieval system or otherwise, without prior permission of the publisher.

THIS PAGE PURPOSEFULLY LEFT BLANK

# American National Standard for Hardwood and Decorative Plywood

## 1. PURPOSE AND INTENDED USE

**1.1 PURPOSE** – The purpose of this Standard is to establish an internationally recognized national standard covering the aesthetic and performance criteria for the principal types, grades, and sizes of hardwood and decorative plywood. The principal wood species used for hardwood and decorative plywood are hardwoods; however, certain softwood species and woody grasses are also used.<sup>1</sup>

**1.2 INTENDED USE** – This Standard is to apply to panels as originally manufactured. The products covered by this Standard are intended for use as decorative wall panels, industrial panels, cut-to-size panels, made-to-size panels, stock panels, door skins and other applications.<sup>2</sup> The Standard also provides architects, designers, contractors, builders, distributors, fabricators, retailers and end-users with a common basis for understanding the characteristics of decorative and hardwood plywood panels.

## 2. SCOPE AND CLASSIFICATION

**2.1 SCOPE** – This Standard covers the principal types, face grades, back grades, inner ply grades and constructions of plywood made primarily with hardwood faces. Included are requirements for wood veneer grading; cores of veneer, lumber, particleboard, Oriented Strand Board (OSB), fiberboard (MDF), and combinations thereof, i.e., bond line performance, panel construction, moisture content; formaldehyde emissions requirements; and panel dimensional tolerances. Test procedures are provided or referenced for determining conformance with the applicable requirements in this Standard. Definitions of trade terms, methods of ordering, and methods for identifying products which conform to this Standard are included.

Formaldehyde emission requirements are also set forth for industrial cut-to-size and stock panel plywood, and for hardwood plywood and certain reconstituted wood wall panels.<sup>3, 4</sup>

**2.2 CLASSIFICATION** – Plywood covered by this Standard is classified as follows:

**2.2.1 COMMERCIAL SPECIES AND COMMERCIAL SPECIES GROUPS** – The more commonly used species for plywood faces are listed in Table 1.

**2.2.2 GRADES OF VENEERS** – The grades of veneers are listed below with the identification symbol for each grade:

Face Grades	AA, A, B, C, D, and E
Rustic Grade	R
Specialty Grade	SP
Back Grades	1, 2, 3, and 4
Inner Ply Grades	J, K, L, and M

The veneer face thickness will vary according to the design and intended use as specified by the manufacturer.

<sup>1</sup> This Standard also includes certain softwood species for decorative uses. Construction grades of plywood (predominately softwood species) are covered in the U.S. Product Standard PS 1-19 for Construction and Industrial Plywood, or the latest edition.

<sup>2</sup> Additional product information is available from the Hardwood Plywood and Veneer Association® (DBA Decorative Hardwoods Association), 42777 Trade West Drive, Sterling, VA 20166.

<sup>3</sup> The formaldehyde emission requirements set forth in this Standard for hardwood plywood and industrial panels are consistent with those established by Environmental Protection Agency (EPA) (40 CFR Part 770) and the California Air Resources Board (CARB) Air Toxic Control Measure (ATCM) CCR Title 17, section 93120 et seq. Formaldehyde emission requirements for reconstituted wood wall panels are consistent with those established by EPA and CARB for hardwood plywood; however, the chamber test loading rates applied to reconstituted wood wall panels in this voluntary product standard relate more to particleboard decking and underlayment than to wall panel applications in manufactured homes.

<sup>4</sup> This Standard also includes formaldehyde emission requirements for reconstituted wood wall panel products made with binders and used for decorative hardwood plywood. More extensive requirements for some reconstituted wood panel products are covered in other standards such as the latest edition of American National Standard ANSI A208.1 for Particleboard and ANSI A208.2 for MDF.

**2.2.3 TYPES OF PLYWOOD** – The types of plywood are listed below in descending order of water resistance of the bond line (see Table 9b).

Technical	(Exterior bond line)
Type I	(Exterior bond line)
Type II	(Interior bond line)

**2.2.4 CONSTRUCTIONS** – The constructions, based on the kinds of cores, commonly in 2-ply, 3-ply, 5-ply, and other odd or even configurations are listed below:

1. Veneer core
2. Lumber core
3. Particleboard core
4. Fiberboard (MDF) core
5. Hardboard core
6. Combination core (multiple plies of VC and composite core)
7. Oriented Strand Board (OSB) core
8. Special core

**2.2.5 SIZES AND THICKNESSES** – Hardwood Plywood may be manufactured in any specified length, width, and thickness depending on the capabilities of the manufacturer. Panel sizes such as 1219 x 1829 mm (48 by 72 inches), 1219 x 2438 mm (48 by 96 inches), and 1219 x 3048 mm (48 by 120 inches) with thicknesses ranging from 3.2 mm (1/8 inch) to 38 mm (1.5 inches) are common.

**2.2.6 PANEL PERFORMANCE PROPERTIES** – Hardwood Plywood is manufactured for non-structural decorative applications consisting of faces and backs applied to a variety of cores and core types, including veneer cores, composite cores, combination cores, and other specialty cores. Each core, species, thickness, and final construction has its own range of physical performance properties and natural characteristics. A variety of adhesives are also used in manufacturing. Due to the variability inherent in the final product, an agreement between buyer and seller shall be made when performance properties are necessary for the intended use and shall reference the appropriate performance standards (MOR, MOE, screw withdrawal, water absorption, thickness swell, etc.) For additional information, see Appendix D.

**TABLE 1 – A COMPARISON OF THE PHYSICAL PROPERTIES OF SOME POPULAR SPECIES  
IN LUMBER FORM**

<u>Species</u>		Average Dried Weight (lb./ft <sup>3</sup> )	Category See § 3.7	Hardness (lbf)	Specific Gravity	Modulus of Elasticity (million PSI)
Ash, White, Avg. of 4 Species	<i>Fraxinus spp.</i>	42	A	1,320	0.60	1.17
Birch, Avg. of 3 Species	<i>Betula spp.</i>	42	A	1,213	0.61	1.92
Hickories, True Average of 4 Species	<i>Carya spp.</i>	51	A	1,574	0.75	2.2
Oaks, Commercial Red Average of 9 Species	<i>Quercus spp.</i>	43	A	1,290	0.63	1.82
Oaks, Commercial White Average of 6 Species	<i>Quercus spp.</i>	47	A	1,360	0.68	1.78
Cherry, Black	<i>Prunus serotina</i>	35	B	950	0.50	1.49
Douglas fir	<i>Pseudotsuga menziesii</i>	30	B	710	0.48	1.95
Gum	<i>Liquidambar styraciflua</i>	34	B	850	0.52	1.64
Mahogany, African	<i>Khaya ivorensis</i>	34	B	830	0.55	1.4
Maple, Hard	<i>Acer saccharum</i>	43	B	1,450	0.63	1.83
Maple, Soft	<i>Acer rubrum, Acer saccharinum</i>	38	B	950	0.54	1.64
Poplar, Yellow	<i>Liriodendron tulipifera</i>	29	B	540	0.45	1.58
Walnut (Black), American	<i>Juglans nigra</i>	38	B	1,010	0.55	1.68
Alder, Red	<i>Alnus rubra</i>	28	C	590	0.41	1.38
Basswood	<i>Tilia americana</i>	26	C	410	0.37	1.46
Meranti, Light Red	<i>Shorea spp.</i>	34	C	460	0.55	1.23
Meranti, Yellow	<i>Shorea spp.</i>	40	C	770	0.65	1.55
Meranti, Dark Red	<i>Shorea spp.</i>	44	C	780	0.71	1.77
Meranti, White	<i>Shorea spp.</i>	41	C	1,140	0.67	1.49
Pine, Southern Yellow	<i>Pinus spp.</i>	32	C	690	0.51	1.79
Pine, White	<i>Pinus spp.</i>	22	C	380	0.35	1.24

**Notes:**

Physical Properties values are given for wood at 12% moisture content.

Hardness represents the relative toughness of wood and its ability to withstand marks and wear. The numerical value represents the force needed to embed a 0.444-inch ball one-half its diameter in the wood. Note that many of these species are used as very thin (~1/50") face veneers. The true "hardness" of the plywood panel itself is therefore more dependent on the species of the inner plies and/or composition of the panel substrate (e.g. particleboard, medium density fiberboard, etc.)

### 3. REQUIREMENTS

**3.1 GENERAL** – Products represented as complying with this Standard shall meet all of the applicable requirements specified herein. Terms used in this Standard shall be as defined in Section 5.

**3.1.1 LEGALLY LOGGED WOOD** – Wood used under this Standard shall be harvested in compliance with the laws of a U.S. state, U.S. federal government, or any foreign law that protects plants or timber. The American National Standard for Due Diligence in Procuring/Sourcing Legal Timber (LTDD) is an effective tool for supporting compliance with this section.

**3.2 SPECIES FOR FACES, BACKS, AND INNER PLYS** – The species for the face, back, and inner plies shall be from any hardwood, softwood, or woody grass. The panels shall be identified by the species of the faces (see 3.17). Designation of the face species is not required for wall panels when the surface is a decorative simulation, such as that of a wood grain of another species. The species of industrial panel backs shall be the same as the faces for panels having grade 1, 2, or 3 backs, unless otherwise designated (see 3.17). Special backs such as resin impregnated paper are permitted as agreed to by the buyer and seller, provided all requirements of this Standard are met. Species of wood commonly used for veneers are listed in Table 1.

**3.3 FACE GRADE DESCRIPTIONS** – The grade requirements and identification symbols for hardwood veneers are given in 3.3.2 through 3.3.10. The patterns achieved by the various cuts (rotary, flat, and quartered) for selected hardwood species are listed in Table 2. When faces consist of more than one piece, the edges shall appear parallel. Book and slip match faces are illustrated in Figure 1. Face grade characteristics for important commercial species appear in Tables 3.1a through 3.5b and Tables 4 and 5. Softwood veneer characteristics are given in 3.3.10 and in Table 6. The requirements for veneer and manufacturing characteristics relate to the minimum requirements for that grade. Natural characteristics which are not specifically limited in the paragraphs and tables referenced above, e.g., burls and pin knots that are not conspicuous, cross figure, and ray fleck in species other than oak, are not restricted unless specified otherwise and agreed upon by the buyer and seller. Other hardwood species not specifically listed in Table 1, Table 2, and Tables 3.1a through 3.5b are also covered by this Standard. For unlisted species, the buyer and seller shall select from species groupings in Tables 3.1a through 3.5b, Tables 4, 5, or 6 most similar to the product required as a basis for the grade of the unlisted species. For other applications, and as agreed to by buyer and seller, requirements for veneer and manufacturing characteristics are not prohibited from being more restrictive than those outlined in 3.3.2 through 3.3.10 and as listed in Tables 3.1a through 3.5b and in Tables 4, 5 and 6. When unsanded face veneers are graded, rough areas of grain, shallow depressions, machine marks and other such characteristics which are capable of being corrected by sanding are not considered. Panels shall be identified by the veneer

species and grade of the face (see 3.17). A tolerance of 5 percent of the shipment or order is allowed (see Appendix A1).

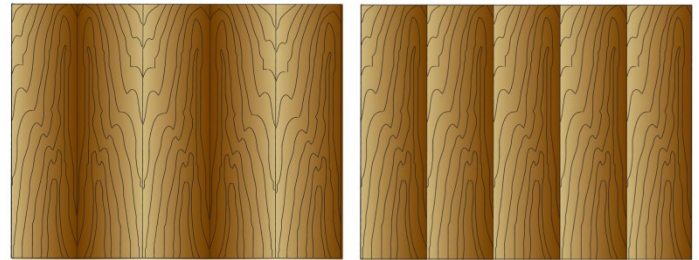

**BOOK MATCHING**

**SLIP MATCHING**

**Figure 1 – Face Matching**

(For more examples of face matching and matching arrangements, see *Hardwood Plywood Handbook* available at [www.decorativehardwoods.org](http://www.decorativehardwoods.org))

**3.3.1 FACE APPEARANCE – GENERAL** – Hardwood plywood shall be graded in accordance with sections 3.3.2 through 3.3.9, Tables 3.1a through 3.5b, and Tables 4, 5 and 6. The grade characteristics described in these paragraphs and tables are based primarily on appearance features with a fewer number of natural characteristics in grade AA. More and larger characteristics are allowed progressively with the alphabetical grade designation. In addition, grain configuration, figure, ability to achieve a full cathedral in plain sliced veneer, amount of distorted grain, amount of end grain, and other similar appearance features shall be taken into consideration when determining the grade classification. This provision applies to figure only in a general sense as mentioned in NOTE on the following page, and to certain elements of figure specifically addressed in the grade tables, e.g. color variation, burls, knots, cross bars, slope, sweep, and flake. It does not apply to any particular recognized decorative patterns, e.g., birdseye, burl, fiddleback, pommele, etc., which are sometimes requested for architectural or other special projects. Special decorative figure of this type is not defined in the Standard. Such figure characteristics should be clearly defined between buyer and seller and must be addressed independently of grade by other means such as a supplemental written specification, or by individual selection of specific flitches to be used.

**TABLE 2 – COMMON FACE VENEER PATTERNS FOR SELECTED COMMERCIAL SPECIES**

Primary Commercial Species	Face Veneer Patterns <sup>a</sup>			
	Plain-Sliced (Flat-Cut)	Quarter-Cut	Rift-Cut and Comb Grain	Rotary-Cut
Ash	Yes	Yes	---	Yes
Alder	Yes	---	---	---
Basswood	Yes	---	---	Yes
Birch	Yes	---	---	Yes
Cherry	Yes	Yes	---	Yes
Douglas fir	Yes	Yes	---	---
Gum	Yes	Yes	Yes	---
Hickory/Pecan	Yes	Yes	---	Yes
Lauan	---	Yes	---	Yes
Khaya	Yes	Yes	---	Yes
Maple	Yes	Yes	---	Yes
Meranti	---	Yes	---	Yes
Oak (Red)	Yes	Yes	Yes	Yes
Oak (White)	Yes	Yes	Yes	Yes
Southern Yellow Pine	Yes	Yes	---	---
Walnut (Black)	Yes	Yes	---	Yes
Yellow Poplar	Yes	---	---	Yes
Typical Methods of Cutting <sup>b</sup>	Vertical or Longitudinal Slicing, or Half-Round on Lathe	Quarter Slicing	Off-Set Quarter on Lathe	Rotary Lathe

<sup>a</sup> The headings above refer to the face veneer pattern, not to the method of cutting. Face veneer patterns other than those listed above are obtainable by special order.

<sup>b</sup> The method of cutting for a given face veneer pattern shall be at mill option unless otherwise specified by the buyer in an explicit manner to avoid the possibility of misunderstanding. For example, specifying plain sliced veneer cut on a vertical slicer or specifying plain sliced veneer cut on a half round lathe.

**NOTE:** Many of the products covered in this Standard are decorative. This note is provided only as explanatory information for linking various natural characteristics in wood to grades based on the appearance of such characteristics on the exposed face surface or surfaces. Wood is a natural material. Thus, its appearance is influenced by a number of factors uncontrolled by humans. In temperate zones, the primary growing seasons affect the formation of springwood and summerwood which can result in wood with different cellular porosity and appearance as it is formed during the spring and summer seasons. These differences can be pronounced in some species. The outer sapwood is often distinctly different and lighter in color from the inner heartwood due to the presence of colored extraneous components (chemical compounds) in the heartwood. The presence of adventitious buds and limbs that are pruned by nature are responsible for the formation of small pin knots and some larger knots. Minerals and other soil factors can result in color variation in wood. Insects, vines, other living

things, and variants of nature can interact with the living tree causing colorations and wounds which are healed by the living tree organism. These natural processes are, in part, responsible for the inherent natural characteristics or imprints in wood. These factors often act differently in different species. For example, pecan can be characterized by much color variation in grain, in part, because of the “pecky” nature of the wood. Pecan, walnut, and cherry often have a relatively large number of pin knots. Some species, such as birch, have a relatively small number of conspicuous natural imprints; however, no species and no tree can be totally free of these characteristics. **Because of the inherent individuality of trees, consideration should be given to the overall appearance of the veneer face to determine the appropriate grade for that veneer.**

**3.3.2 GRADE AA** – The veneer shall be smooth, tight-cut, and full-length. When the face consists of more than one veneer component or piece, the edges shall appear parallel and be edge matched as described for the various species in Tables 3.1a through 3.5b, and Table 4. All components of a book or slip matched face shall be from the same flitch. Rotary-cut faces shall be whole piece or multi-piece with edge joints tight with no sharp color contrasts at the joints. Species specified for natural color will allow color contrasts but must be book matched or conform to the type of matching as specified. The components of plain-sliced (flat-cut) and multi-piece rotary-cut faces shall be book matched, unless otherwise specified with a running, balanced, or center matched arrangement. Unless otherwise specified, components in plain-sliced faces shall have a matching arrangement selected by the manufacturer. Plain-sliced faces shall consist of two or more components. Rotary-cut faces shall consist of one or more components. Neither plain-sliced nor rotary-cut faces shall have any components, except outside components, that are less than 152 mm (6 inches) in width. Outside components shall be sized to allow for certain types of matching or panel edge trim loss. No plain-sliced components shall have a split heart. No full quarter-cut is allowed in plain-sliced faces. The width of any single component in quarter-cut, rift-cut, or comb grain faces, except outside components, shall not be less than 76 mm (3 inches). Outside components shall be sized to allow for certain types of matching or panel edge trim loss.

**3.3.3 GRADE A** – The veneer shall be smooth, tight-cut, and full-length. When the face consists of more than one veneer component or piece, the edges shall appear parallel and be edge matched as described for the various species in Tables 3.1a through 3.5b, and Tables 4, 5, and 6. All components of a book or slip matched face shall be from the same flitch. Rotary-cut faces shall be whole piece or be multi-piece with edge joints tight; however, no sharp color contrasts are permitted at the joints and the face shall provide a good general appearance. Species specified for natural color will allow color contrasts, but must be book matched or conform to the type of matching as specified. The components of plain-sliced (flat-cut) and multi-piece rotary-cut faces shall be book matched, unless otherwise specified with a running, balanced, or center matched arrangement. Unless otherwise specified, components in plain-sliced faces shall have a matching arrangement selected by the manufacturer. Plain-sliced faces shall consist of two or more components. Rotary-cut faces shall consist of one or more components. Neither plain-sliced nor rotary-cut faces shall have any components, except outside components, that are less than 127 mm (5 inches) in width. Outside components shall be sized to allow for matching or panel edge trim loss. There shall not be any split heart in plain-sliced faces unless manufactured cathedral is achieved. (See definition for split heart in Section 5, DEFINITIONS). No full quarter-cut is allowed in plain-sliced faces. The width of any single component in quarter-cut, rift-cut, or comb grain faces, except outside components, shall not be less than 76 mm (3 inches). Outside components shall be sized to allow for matching or panel edge trim loss. Sapwood and heartwood requirements shall be in accordance with Tables 3.1a through 3.5b, Tables 4,5, and 6.

**3.3.4 GRADE B** – The veneer shall be smooth, tight-cut, and full-length as described for the various species in Tables 3.1a through 3.5b. Slip or book matched veneers are available if specified by the buyer. In sliced veneer, all components of a book or slip matched face shall be from the same flitch. If not specified, multi-piece faces shall be pleasing matched for color. Sharp color contrasts at the joints are not permitted. Species specified for natural color will allow color contrasts but must be pleasing matched or conform to the type of matching as specified. Plain sliced, quarter cut, rift cut, and comb grain faces shall consist of two or more components with no component, except outside components, being less than 76 mm (3 inches) wide. Rotary-cut faces shall consist of one or more components with no component, except outside components, being less than 102 mm (4 inches) wide. Outside components shall be sized to allow for certain types of matching or panel edge trim loss. Sapwood and heartwood requirements shall be in accordance with Tables 3.1a through 3.5b, Tables 4, 5, and 6.

**3.3.5 GRADE C** – Requirements for grade C faces appear in Tables 3.1a through 3.5b, Table 5, and Table 6. The grade permits unlimited color streaks and spots and color variation. An unlimited number of small burls and pin knots are allowed with no restrictions on the size of the dark pin knot centers as long as the diameter of pin knots does not exceed 6.4 mm (1/4 inch) in diameter. The size of sound and repaired knotholes and similar shaped openings shall not exceed 12.7 mm (1/2 inch) in diameter with a specified number allowed based on individual species. Grade C faces shall provide a sound face, free of open defects.



TABLE 3.1a – SUMMARY OF HARDWOOD FACE GRADE CHARACTERISTICS – Ash, Beech,<sup>b</sup> Birch, Maple and Poplar

METRIC

NOTE: Because of the inherent individuality of trees, consideration should be given to the overall appearance of the veneer face to determine the appropriate grade for that veneer.

Cut	Plain-Sliced (Flat-Cut), Quarter-Cut, Rotary-Cut – See Table 2 for Common Face Veneer Patterns											
Grade Description	AA			A			B			C	D	E
Color and Matching	Sap	Heart	Nat.	Sap	Heart	Nat.	Sap	Heart	Nat.			
Sapwood	Yes	No	Yes	Yes	No	Yes	Yes	No	Yes	Yes	Yes	Yes
Heartwood	No	Yes	Yes	No	Yes	Yes	No	Yes	Yes	Yes	Yes	Yes
Color Streaks or Spots	Slight			Slight	Yes		Yes			Yes	Yes	Yes
Color Variation	Slight		Yes	Slight	Yes		Yes			Yes	Yes	Yes
Sharp Color Contrasts at Joints	Yes if Slip, Plank or Random matched			Yes if Slip, Plank or Random matched			Yes if Slip, Plank or Random matched			Yes	Yes	Yes
Type of Matching												
Book Matched	Yes			Yes			Specify			--	--	--
Slip Matched	Specify			Specify			Specify			--	--	--
Pleasant Matched	--			--			Yes			--	--	--
Nominal Minimum Width of Face Components <sup>a</sup>	Plain-S.	152 mm		Quarter	76 mm		Rotary	152 mm		No Limit	No Limit	No Limit
		127 mm			76 mm			102 mm				
<b>Natural Characteristics (Except as limited below, natural characteristics are not restricted.)</b>												
Inconspicuous Burls & Pin Knots – Combined Avg. Number	2 per 1 m <sup>2</sup>			4 per 1 m <sup>2</sup>			6 per 1 m <sup>2</sup>			No Limit	No Limit	No Limit
Conspicuous Burls – Max. Size	6.4 mm			9.5 mm			12.7 mm			No Limit	No Limit	No Limit
Conspicuous Pin Knots Avg. Number	No			4 per 3 m <sup>2</sup>			3 per 1 m <sup>2</sup>			No Limit	No Limit	No Limit
Max. Size: Dark Part Total				3.2 mm			3.2 mm					
				6.4 mm			6.4 mm					
Scattered Sound and Repaired Knots – Combined Avg. Number	No			No			4 per 3 m <sup>2</sup>			3 per 1 m <sup>2</sup>	4 per 1 m <sup>2</sup>	No Limit
Max. Size – Sound							9.5 mm			12.7 mm	25.4 mm	38 mm
Max. Size – Repaired							3.2 mm			12.7 mm	19 mm	25.4 mm
Avg. No. – Repaired							4 per 3 m <sup>2</sup>			4 per 3 m <sup>2</sup>	2 per 1 m <sup>2</sup>	6 per 1 m <sup>2</sup>
Mineral Streaks	No; Maple, Slight			Slight			Slight			Yes	Yes	Yes
Bark Pockets	No			No			Few to 3.2 mm x 25.4 mm			Few to 6.4 mm x 50.8 mm	6.4 mm x 50.8 mm	Yes
Worm Tracks	Slight			Slight			Slight; Ash, yes			Yes	Yes	Yes
Vine Marks	Slight			Slight			Slight			Yes	Yes	Yes
Cross Bars	Slight			Slight			Yes			Yes	Yes	Yes
<b>Manufacturing Characteristics</b>												
Rough Cut / Ruptured Grain	No			No			Slight			Two 203 mm dia. areas or equivalent	5% of panel	10% of panel
Blended Repaired Tapering Hairline Splits	Two 0.8 mm x 76 mm on panel ends only			Two 1.6 mm x 152 mm			Four 3.2 mm x 203 mm			Four 4.8 mm x 203 mm	Six 6.4 mm x 254 mm	Yes
Repairs	Very Small Blending			Small Blending			Blending			Yes	Yes	Yes
<b>Special Characteristics (Except as limited below, special natural characteristics are not restricted.)</b>												
Quartered	25.4 mm in 305 mm maximum grain slope, 63.5 mm in 305 mm maximum grain sweep											

Unfilled wormholes, open splits, open joints, open bark pockets, or doze not allowed in above grades.

<sup>a</sup> Outside components will be a different size to allow for edge trim loss and certain types of matching.<sup>b</sup> American or European

**TABLE 3.2a – SUMMARY OF HARDWOOD FACE GRADE CHARACTERISTICS – Mahogany, Anege, Makore, Sapele and other veneers with similar characteristics See paragraph 3.3**

**METRIC**

NOTE: Because of the inherent individuality of trees, consideration should be given to the overall appearance of the veneer face to determine the appropriate grade for that veneer.

Cut	Plain-Sliced (Flat-Cut), Quarter-Cut, Rotary-Cut – See Table 2 for Common Face Veneer Patterns					
Grade Description	AA	A	B	C	D	E
<b>Color and Matching</b>						
Sapwood	No	No	No	Yes	Yes	Yes
Heartwood	Yes	Yes	Yes	Yes	Yes	Yes
Color Streaks or Spots	Slight	Slight	Occasional	Yes	Yes	Yes
Color Variation	Slight	Slight	Moderate	Yes	Yes	Yes
Sharp Color Contrasts at Joints	Yes if Slip, Plank or Random matched	Yes if Slip, Plank or Random matched	Yes if Slip, Plank or Random matched	Yes	Yes	Yes
Type of Matching						
Book Matched	Yes	Yes	Specify	--	--	--
Slip Matched	Specify	Specify	Specify	--	--	--
Pleasant Matched	--	--	Yes	--	--	--
Nominal Minimum Width of Face Components <sup>a</sup>	Plain-S. 152 mm Quarter 76 mm Rotary 152 mm	127 mm 76 mm 127 mm	76 mm 76 mm 102 mm	No Limit	No Limit	No Limit
<b>Natural Characteristics (Except as limited below, natural characteristics are not restricted.)</b>						
Inconspicuous Burls & Pin Knots – Combined Avg. Number	2 per 1 m <sup>2</sup>	4 per 1 m <sup>2</sup>	6 per 1 m <sup>2</sup>	No Limit	No Limit	No Limit
Conspicuous Burls – Max. Size	6.4 mm	9.5 mm	12.7 mm	No Limit	No Limit	No Limit
Conspicuous Pin Knots Avg. Number	No	4 per 3 m <sup>2</sup>	3 per 1 m <sup>2</sup>	No Limit	No Limit	No Limit
Max. Size: Dark Part Total		3.2 mm 6.4 mm	3.2 mm 6.4 mm			
Scattered Sound and Repaired Knots – Combined Avg. Number	No	No	4 per 3 m <sup>2</sup>	3 per 1 m <sup>2</sup>	4 per 1 m <sup>2</sup>	No Limit
Max. Size – Sound			9.5 mm	12.7 mm	25.4 mm	38 mm
Max. Size – Repaired			3.2 mm	12.7 mm	19 mm	25.4 mm
Avg. No. – Repaired			4 per 3 m <sup>2</sup>	4 per 3 m <sup>2</sup>	2 per 1 m <sup>2</sup>	6 per 1 m <sup>2</sup>
Mineral Streaks	No	Slight	Occasional	Yes	Yes	Yes
Bark Pockets	No	No	Few to 3.2 mm x 25.4 mm	Few to 6.4 mm x 50.8 mm	6.4 mm x 50.8 mm	Yes
Worm Tracks	No	No	Slight	Few	Yes	Yes
Vine Marks	Slight	Slight	Yes	Yes	Yes	Yes
Cross Bars	Occasional	Occasional	Yes	Yes	Yes	Yes
<b>Manufacturing Characteristics</b>						
Rough Cut / Ruptured Grain	No	No	Slight	Slight	Two 203 mm dia. areas or equivalent	5% of panel
Blended Repaired Tapering Hairline Splits	Two 0.8 mm x 76 mm on panel ends only	Two 1.6 mm x 152 mm	Two 3.2 mm x 203 mm	Four 4.8 mm x 203 mm	Six 6.4 mm x 254 mm	Yes
Repairs	Very Small Blending	Small Blending	Blending	Yes	Yes	Yes
<b>Special Characteristics (Except as limited below, special natural characteristics are not restricted.)</b>						
Unfilled Wormholes	No	No	No	1.6 mm max. dia.	1.6 mm max. dia.	1.6 mm max. dia.
Quartered	25.4 mm in 305 mm maximum grain slope, 63.5 mm in 305 mm maximum grain sweep					

Open splits, open joints, open bark pockets, or doze not allowed in above grades.

<sup>a</sup> Outside components will be a different size to allow for edge trim loss and certain types of matching.

Filed By: tbrightbill@wiley.law, Filed Date: 5/22/25 12:49 AM, Submission Status: Approved

**TABLE 3.3a – SUMMARY OF HARDWOOD FACE GRADE CHARACTERISTICS – Red and White Oak –****METRIC**

NOTE: Because of the inherent individuality of trees, consideration should be given to the overall appearance of the veneer face to determine the appropriate grade for that veneer.

Cut	Plain-Sliced (Flat-Cut), Quarter-Cut, Rift and Comb Grain, Rotary-Cut – See Table 2 for Common Face Veneer Patterns								
Grade Description	AA		A		B		C	D	E
	Red Oak	White Oak	Red Oak	White Oak	Red Oak	White Oak			
<b>Color and Matching</b>									
Sapwood	No	No	5% <sup>a</sup>	Yes <sup>a</sup>	10-20% <sup>b</sup>	Yes	Yes	Yes	Yes
Heartwood	Yes	Yes	Yes	Yes	Yes	Yes	Yes	Yes	Yes
Color Streaks or Spots	Yes		Yes		Yes		Yes	Yes	Yes
Color Variation	Slight		Slight		Yes		Yes	Yes	Yes
Sharp Color Contrasts at Joints	Yes if Slip, Plank or Random matched		Yes if Slip, Plank or Random matched		Yes if Slip, Plank or Random matched		Yes	Yes	Yes
Type of Matching									
Book Matched	Yes		Yes		Specify		--	--	--
Slip Matched	Specify		Specify		Specify		--	--	--
Pleasant Matched	--		--		Yes		--	--	--
Nominal Minimum Width of Face Components <sup>c</sup>	Plain-S. Quar/Rift Rotary	152 mm 76 mm 152 mm	127 mm 76 mm 127 mm	127 mm 76 mm 127 mm	76 mm 76 mm 102 mm		No Limit	No Limit	No Limit
<b>Natural Characteristics (Except as limited below, natural characteristics are not restricted.)</b>									
Inconspicuous Burls & Pin Knots – Combined Avg. Number	3 per 1 m <sup>2</sup>		Yes; Blending		Yes; Blending		No Limit	No Limit	No Limit
Conspicuous Burls – Max. Size	6.4 mm		9.5 mm		12.7 mm		No Limit	No Limit	No Limit
Conspicuous Pin Knots Avg. Number	No		4 per 1 m <sup>2</sup>		6 per 1 m <sup>2</sup>		No Limit	No Limit	No Limit
Max. Size: Dark Part Total			3.2 mm 6.4 mm		3.2 mm 6.4 mm				
Scattered Sound and Repaired Knots – Combined Avg. Number	No		No		4 per 3 m <sup>2</sup>		3 per 1 m <sup>2</sup>	4 per 1 m <sup>2</sup>	No Limit
Max. Size – Sound					9.5 mm		12.7 mm	25.4 mm	38 mm
Max. Size – Repaired					3.2 mm		12.7 mm	19 mm	25.4 mm
Avg. No. – Repaired					4 per 3 m <sup>2</sup>		4 per 3 m <sup>2</sup>	2 per 1 m <sup>2</sup>	6 per 1 m <sup>2</sup>
Mineral Streaks	No		Blending		1 row unlimited up to 305 mm long		Yes	Yes	Yes
Bark Pockets	No		No		Few to 3.2 mm x 25.4 mm		Few to 6.4 mm x 50.8 mm	6.4 mm x 50.8 mm	Yes
Worm Tracks	No		No		Slight		Few	Yes	Yes
Vine Marks	No		Slight		Yes		Yes	Yes	Yes
Cross Bars	Slight		Slight		Yes		Yes	Yes	Yes
<b>Manufacturing Characteristics</b>									
Rough Cut / Ruptured Grain	No		No		Slight		Slight	Two 203 mm dia. areas or equivalent	5% of panel
Blended Repaired Tapering Hairline Splits	Two 0.8 mm x 76 mm on panel ends only		Two 1.6 mm x 152 mm		Four 3.2 mm x 203 mm		Four 4.8 mm x 203 mm	Six 6.4 mm x 254 mm	Yes
Repairs	Very Small Blending		Small Blending		Blending		Yes	Yes	Yes
<b>Special Characteristics (Except as limited below, special natural characteristics are not restricted.)</b>									
Ray Fleck <sup>d</sup>	Slight, Blending		Slight, Blending		Slight, Blending		Yes	Yes	Yes
Rift and Comb Grain	Rift permits 25.4 mm in 305 mm maximum grain slope, 63.5 mm in 305 mm maximum grain sweep, fleck not to exceed 9.5 mm in width. Comb permits 12.7 mm in 305 mm maximum grain slope, 12.7 mm in 305 mm maximum grain sweep, fleck not to exceed 2.4 mm in width.								

Unfilled wormholes, open splits, open joints, open bark pockets, or doze not allowed in above grades.

<sup>a</sup> Sap allowed in rotary-cut only unless otherwise specified. <sup>b</sup> 10% sap allowed in rift, comb, quarter-cut and plain-sliced; 20% sap allowed in rotary-cut. <sup>c</sup> Outside components will be a different size to allow for edge trim loss and certain types of matching. <sup>d</sup> Unless otherwise specified, quartered permits unlimited fleck.

**TABLE 3.4a – SUMMARY OF HARDWOOD FACE GRADE CHARACTERISTICS – Pecan and Hickory –****METRIC**

NOTE: Because of the inherent individuality of trees, consideration should be given to the overall appearance of the veneer face to determine the appropriate grade for that veneer.

Cut		Plain-Sliced (Flat-Cut), Quarter-Cut, Rotary-Cut – See Table 2 for Common Face Veneer Patterns				
Grade Description		AA	A	B	C	1 (Back)
<b>Color and Matching</b>						
Sapwood		Yes	Yes	Yes	Yes	Yes
Heartwood		Yes	Yes	Yes	Yes	Yes
Color Streaks or Spots		Yes	Yes	Yes	Yes	Yes
Color Variation		Yes	Yes	Yes	Yes	Yes
Sharp Color Contrasts at Joints		Yes if Slip, Plank or Random matched	Yes if Slip, Plank or Random matched	Yes if Slip, Plank or Random matched	Yes	Yes
Type of Matching						
Book Matched		Yes	Yes	Specify	--	--
Slip Matched		Specify	Specify	Specify	--	--
Pleasant Matched		--	--	Yes	--	--
Nominal Minimum Width of Face Components <sup>a</sup>	Plain-S.	152 mm	127 mm	76 mm	No Limit	No Limit
	Quarter	76 mm	76 mm	76 mm		
	Rotary	152 mm	127 mm	102 mm		
<b>Natural Characteristics (Except as limited below, natural characteristics are not restricted.)</b>						
Inconspicuous Burls & Pin Knots – Combined Avg. Number		11 per 1 m <sup>2</sup>	22 per 1 m <sup>2</sup>	No Limit	No Limit	No Limit
Conspicuous Burls – Max. Size		6.4 mm	9.5 mm	12.7 mm	No Limit	No Limit
Conspicuous Pin Knots <sup>b</sup>						
Avg. Number		6 per 1 m <sup>2</sup>	22 per 1 m <sup>2</sup>	No Limit	No Limit	No Limit
Max. Size: Dark Part		3.2 mm	3.2 mm	3.2 mm		
Total		6.4 mm	6.4 mm	6.4 mm		
Scattered Sound and Repaired Knots – Combined Avg. Number		No	No	4 per 3 m <sup>2</sup>	4 per 1 m <sup>2</sup>	8 per 3 m <sup>2</sup>
Max. Size – Sound				9.5 mm	12.7 mm	9.5 mm
Max. Size – Repaired				3.2 mm	12.7 mm	3.2 mm
Avg. No. – Repaired				4 per 3 m <sup>2</sup>	2 per 1 m <sup>2</sup>	8 per 3 m <sup>2</sup>
Mineral Streaks		Slight	Slight	Yes	Yes	Yes
Bark Pockets		No	Small, Occasional	Few to 6.4 mm x 50.8 mm	Few to 9.5 mm x 102 mm	Few to 9.5 mm x 102 mm
Worm Tracks		No	Slight	Few	Yes	Yes
Vine Marks		Slight	Occasional	Yes	Yes	Yes
Cross Bars		Slight	Occasional	Yes	Yes	Yes
<b>Manufacturing Characteristics</b>						
Rough Cut / Ruptured Grain		No	No	Slight	Two 203 mm dia. areas or equivalent	Two 203 mm dia. areas or equivalent
Blended Repaired Tapering Hairline Splits		Two 0.8 mm x 76 mm on panel ends only	Two 1.6 mm x 152 mm	Four 3.2 mm x 203 mm	Four 4.8 mm x 203 mm	Four 4.8 mm x 203 mm
Repairs		Very Small Blending	Small Blending	Blending	Yes	Yes
<b>Special Characteristics (Except as limited below, special natural characteristics are not restricted.)</b>						
Bird Peck <sup>c</sup>		No	Slight	Yes	Yes	Yes
Knife Marks		Knife marks may occur in these high-density species.				
Quartered		25.4 mm in 305 mm maximum grain slope, 63.5 mm in 305 mm maximum grain sweep				

Unfilled wormholes, open splits, open joints, open bark pockets, or doze not allowed in above grades.

<sup>a</sup> Outside components will be a different size to allow for edge trim loss and certain types of matching.<sup>b</sup> For pecan and hickory, conspicuous pin knots means sound knots 6.4 mm or less in diameter with dark centers larger than 1.6 mm. Blending pin knots are sound knots 6.4 mm or less in diameter with dark centers 1.6 mm or less and are allowed in all grades of pecan and hickory.<sup>c</sup> To achieve a more rustic appearance, bird peck shall be specified.

**TABLE 3.5a – SUMMARY OF HARDWOOD FACE GRADE CHARACTERISTICS – Walnut and Cherry –****METRIC**

NOTE: Because of the inherent individuality of trees, consideration should be given to the overall appearance of the veneer face to determine the appropriate grade for that veneer.

Cut		Plain-Sliced (Flat-Cut), Quarter-Cut, Rotary-Cut – See Table 2 for Common Face Veneer Patterns					
Grade Description		AA	A	B	C	D	E
<b>Color and Matching</b>							
Sapwood		No	No <sup>a</sup>	No <sup>a</sup>	Yes	Yes	Yes
Heartwood		Yes	Yes	Yes	Yes	Yes	Yes
Color Streaks or Spots		Slight	Slight	Yes	Yes	Yes	Yes
Color Variation		Slight	Slight	Yes	Yes	Yes	Yes
Sharp Color Contrasts at Joints		Yes if Slip, Plank or Random matched	Yes if Slip, Plank or Random matched	Yes if Slip, Plank or Random matched	Yes	Yes	Yes
Type of Matching							
Book Matched		Yes	Yes	Specify	--	--	--
Slip Matched		Specify	Specify	Specify	--	--	--
Pleasant Matched		--	--	Yes	--	--	--
Nominal Minimum Width of	Plain-S. Quarter	152 mm	127 mm	76 mm	No Limit	No Limit	No Limit
Face Components <sup>b</sup>	Rotary	76 mm	76 mm	76 mm			
		152 mm	127 mm	102 mm			
<b>Natural Characteristics (Except as limited below, natural characteristics are not restricted.)</b>							
Inconspicuous Burls & Pin Knots – Combined Avg. Number		3 per 1 m <sup>2</sup>	8 per 1 m <sup>2</sup>	22 per 1 m <sup>2</sup>	No Limit	No Limit	No Limit
Conspicuous Burls – Max. Size		6.4 mm	9.5 mm	12.7 mm	No Limit	No Limit	No Limit
Conspicuous Pin Knots <sup>c</sup>					No Limit	No Limit	No Limit
Avg. Number		3 per 1 m <sup>2</sup>	6 per 1 m <sup>2</sup>	11 per 1 m <sup>2</sup>			
Max. Size: Dark Part		3.2 mm	3.2 mm	3.2 mm			
Total		6.4 mm	6.4 mm	6.4 mm			
Scattered Sound and Repaired Knots – Combined Avg. Number		No	No	4 per 3 m <sup>2</sup>	3 per 1 m <sup>2</sup>	4 per 1 m <sup>2</sup>	No Limit
Max. Size – Sound				9.5 mm	12.7 mm	25.4 mm	38 mm
Max. Size – Repaired				3.2 mm	12.7 mm	19 mm	25.4 mm
Avg. No. – Repaired				4 per 3 m <sup>2</sup>	4 per 3 m <sup>2</sup>	2 per 1 m <sup>2</sup>	6 per 1 m <sup>2</sup>
Mineral Streaks		Slight	Slight	Yes	Yes	Yes	Yes
Bark Pockets		No	No	Few to 3.2 mm x 25.4 mm	Few to 6.4 mm x 50.8 mm	6.4 mm x 50.8 mm	Yes
Worm Tracks		No	No	Slight	Few	Yes	Yes
Vine Marks		Slight	Occasional	Yes	Yes	Yes	Yes
Cross Bars		Slight	Occasional	Yes	Yes	Yes	Yes
<b>Manufacturing Characteristics</b>							
Rough Cut / Ruptured Grain		No	No	Slight	Slight	Two 203 mm dia. areas or equivalent	5% of panel
Blended Repaired Tapering Hairline Splits		Two 0.8 mm x 76 mm on panel ends only	Two 1.6 mm x 152 mm	Four 3.2 mm x 203 mm	Four 4.8 mm x 203 mm	Six 6.4 mm x 254 mm	Yes
Repairs		Very Small Blending	Small Blending	Blending	Yes	Yes	Yes
<b>Special Characteristics (Except as limited below, special natural characteristics are not restricted.)</b>							
Gum Spots		Occasional gum spots in cherry	Occasional gum spots in cherry	Gum spots and gum streaks in cherry	Gum spots and gum streaks in cherry		
Quartered		25.4 mm in 305 mm maximum grain slope, 63.5 mm in 305 mm maximum grain sweep					

Unfilled wormholes, open splits, open joints, open bark pockets, or doze not allowed in above grades.

<sup>a</sup> Sap is allowed in grades A and B; however, the percentage must be agreed upon between buyer and seller.<sup>b</sup> Outside components will be a different size to allow for edge trim loss and certain types of matching.<sup>c</sup> For walnut and cherry, conspicuous pin knots means sound knots 6.4 mm or less in diameter with dark centers larger than 1.6 mm. Blending pin knots are sound knots 6.4 mm or less in diameter with dark centers of 1.6 mm or less and are allowed in all grades of walnut and cherry.

TABLE 3.1b – SUMMARY OF HARDWOOD FACE GRADE CHARACTERISTICS – Ash, Beech<sup>b</sup>, Birch, Maple and Poplar

INCH-POUND

NOTE: Because of the inherent individuality of trees, consideration should be given to the overall appearance of the veneer face to determine the appropriate grade for that veneer.

Cut	Plain-Sliced (Flat-Cut), Quarter-Cut, Rotary-Cut – See Table 2 for Common Face Veneer Patterns											
Grade Description	AA			A			B			C	D	E
Color and Matching	Sap	Heart	Nat.	Sap	Heart	Nat.	Sap	Heart	Nat.			
Sapwood	Yes	No	Yes	Yes	No	Yes	Yes	No	Yes	Yes	Yes	Yes
Heartwood	No	Yes	Yes	No	Yes	Yes	No	Yes	Yes	Yes	Yes	Yes
Color Streaks or Spots	Slight			Slight	Yes		Yes			Yes	Yes	Yes
Color Variation	Slight		Yes	Slight	Yes		Yes			Yes	Yes	Yes
Sharp Color Contrasts at Joints	Yes if Slip, Plank or Random matched			Yes if Slip, Plank or Random matched			Yes if Slip, Plank or Random matched			Yes	Yes	Yes
Type of Matching												
Book Matched	Yes			Yes			Specify			--	--	--
Slip Matched	Specify			Specify			Specify			--	--	--
Pleasant Matched	--			--			Yes			--	--	--
Nominal Minimum	Plain-S.	6 in.		5 in.		3 in.		3 in.		No Limit	No Limit	No Limit
Width of Face	Quarter	6 in.		3 in.		3 in.		3 in.				
Components <sup>a</sup>	Rotary	6 in.		5 in.		4 in.		4 in.				
<b>Natural Characteristics (Except as limited below, natural characteristics are not restricted.)</b>												
Inconspicuous Burls & Pin Knots – Combined Avg. Number	1 per 5 sq ft 6 per 4 ft x 8 ft panel			1 per 3 sq ft 10 per 4 ft x 8 ft panel			1 per 2 sq ft 16 per 4 ft x 8 ft panel			No Limit	No Limit	No Limit
Conspicuous Burls – Max. Size	¼ in.			3/8 in.			½ in.			No Limit	No Limit	No Limit
Conspicuous Pin Knots												
Avg. Number	No			1 per 8 sq ft 4 per 4 x 8 ft panel			1 per 4 sq ft 8 per 4 x 8 ft panel			No Limit	No Limit	No Limit
Max. Size: Dark Part				1/8 in.			1/8 in.					
Total				¼ in.			¼ in.					
Scattered Sound and Repaired Knots – Combined Avg. Number	No			No			1 per 8 sq ft 4 per 4 x 8 ft panel			1 per 4 sq ft 8 per 4 x 8 ft panel	1 per 3 sq ft 10 per 4 x 8 ft panel	No Limit
Max. Size – Sound							3/8 in.			½ in.	½ in.	1 ½ in.
Max. Size – Repaired							1/8 in.			½ in.	1 in.	1 in.
Avg. No. – Repaired							1 per 8 sq ft			1 per 8 sq ft	¾ in.	1 per 2 sq ft
Mineral Streaks	No; Maple, slight			Slight			Slight			Yes	Yes	Yes
Bark Pockets	No			No			Few to 1/8 in. x 1 in.			Few to ¼ in. x 2 in.	¼ in. x 2 in.	Yes
Worm Tracks	Slight			Slight			Slight; Ash, yes			Yes	Yes	Yes
Vine Marks	Slight			Slight			Slight			Yes	Yes	Yes
Cross Bars	Slight			Slight			Yes			Yes	Yes	Yes
<b>Manufacturing Characteristics</b>												
Rough Cut / Ruptured Grain	No			No			Slight			Two 8 in. diameter areas or equivalent	5% of panel	10% of panel
Blended Repaired Tapering Hairline Splits	Two 1/32 in. x 3 in. on panel ends only			Two 1/16 in. x 6 in.			Four 1/8 in. x 8 in.			Four 3/16 in. x 8 in.	Six ¼ in. x 10 in.	Yes
Repairs	Very Small Blending			Small Blending			Blending			Yes	Yes	Yes
<b>Special Characteristics (Except as limited below, special natural characteristics are not restricted.)</b>												
Quartered	1 inch in 12 inches maximum grain slope, 2 ½ inches in 12 inches maximum grain sweep											

Unfilled wormholes, open splits, open joints, open bark pockets, or doze not allowed in above grades.

<sup>a</sup> Outside components will be a different size to allow for edge trim loss and certain types of matching.<sup>b</sup> American or European.

**TABLE 3.2b – SUMMARY OF HARDWOOD FACE GRADE CHARACTERISTICS – Mahogany, Anegre, Makore, Sapele and other veneers with similar characteristics See paragraph 3.3** **INCH-POUND**

NOTE: Because of the inherent individuality of trees, consideration should be given to the overall appearance of the veneer face to determine the appropriate grade for that veneer.

Cut	Plain-Sliced (Flat-Cut), Quarter-Cut, Rotary-Cut – See Table 2 for Common Face Veneer Patterns					
Grade Description	AA	A	B	C	D	E
<b>Color and Matching</b>						
Sapwood	No	No	No	Yes	Yes	Yes
Heartwood	Yes	Yes	Yes	Yes	Yes	Yes
Color Streaks or Spots	Slight	Slight	Occasional	Yes	Yes	Yes
Color Variation	Slight	Slight	Moderate	Yes	Yes	Yes
Sharp Color Contrasts at Joints	Yes if Slip, Plank or Random matched	Yes if Slip, Plank or Random matched	Yes if Slip, Plank or Random matched	Yes	Yes	Yes
Type of Matching						
Book Matched	Yes	Yes	Specify	--	--	--
Slip Matched	Specify	Specify	Specify	--	--	--
Pleasant Matched	--	--	Yes	--	--	--
Nominal Minimum Width of Face Components <sup>a</sup>	Plain-S. 6 in. Quarter 3 in. Rotary 6 in.	5 in. 3 in. 5 in.	3 in. 3 in. 4 in.	No Limit	No Limit	No Limit
<b>Natural Characteristics (Except as limited below, natural characteristics are not restricted.)</b>						
Inconspicuous Burls & Pin Knots – Combined Avg. Number	1 per 5 sq ft 6 per 4ft x 8 ft panel	1 per 3 sq ft 10 per 4 ft x 8 ft panel	1 per 2 sq ft 16 per 4 ft x 8 ft panel	No Limit	No Limit	No Limit
Conspicuous Burls – Max. Size	¼ in.	3/8 in.	½ in.	No Limit	No Limit	No Limit
Conspicuous Pin Knots Avg. Number	No	1 per 8 sq ft 4 per 4 x 8 ft panel	1 per 4 sq ft 8 per 4 x 8 ft panel	No Limit	No Limit	No Limit
Max. Size: Dark Part Total		1/8 in. ¼ in.	1/8 in. ¼ in.			
Scattered Sound and Repaired Knots – Combined Avg. Number	No	No	1 per 8 sq ft 4 per 4 x 8 ft panel	1 per 4 sq ft 8 per 4 x 8 ft panel	1 per 3 sq ft 10 per 4 x 8 ft panel	No Limit
Max. Size – Sound			3/8 in.	½ in.	1 in.	1 ½ in.
Max. Size – Repaired			1/8 in.	½ in.	¾ in.	1 in.
Avg. No. – Repaired			1 per 8 sq ft	1 per 8 sq ft	1 per 6 sq ft	1 per 2 sq ft
Mineral Streaks	No	Slight	Occasional	Yes	Yes	Yes
Bark Pockets	No	No	Few to 1/8 in. x 1 in.	Few to ¼ in. x 2 in.	¼ in. x 2 in.	Yes
Worm Tracks	No	No	Slight	Few	Yes	Yes
Vine Marks	Slight	Slight	Yes	Yes	Yes	Yes
Cross Bars	Occasional	Occasional	Yes	Yes	Yes	Yes
<b>Manufacturing Characteristics</b>						
Rough Cut / Ruptured Grain	No	No	Slight	Slight	Two 8 in. diameter areas or equivalent	5% of panel
Blended Repaired Tapering Hairline Splits	Two 1/32 in. x 3 in. on panel ends only	Two 1/16 in. x 6 in.	Two 1/8 in. x 8 in.	Four 3/16 in. x 8 in.	Six ¼ in. x 10 in.	Yes
Repairs	Very Small Blending	Small Blending	Blending	Yes	Yes	Yes
<b>Special Characteristics (Except as limited below, special natural characteristics are not restricted.)</b>						
Unfilled Wormholes	No	No	No	1/16 in. max. dia.	1/16 in. max. dia.	1/16 in. max. dia.
Quartered	1 inch in 12 inches maximum grain slope, 2 ½ inches in 12 inches maximum grain sweep					

Open splits, open joints, open bark pockets, or doze not allowed in above grades.

<sup>a</sup> Outside components will be a different size to allow for edge trim loss and certain types of matching.

**TABLE 3.3b – SUMMARY OF HARDWOOD FACE GRADE CHARACTERISTICS – Red and White Oak –****INCH-POUND**

NOTE: Because of the inherent individuality of trees, consideration should be given to the overall appearance of the veneer face to determine the appropriate grade for that veneer.

Cut	Plain-Sliced (Flat-Cut), Quarter-Cut, Rift and Comb Grain, Rotary-Cut – See Table 2 for Common Face Veneer Patterns								
Grade Description	AA		A		B		C	D	E
	Red Oak	White Oak	Red Oak	White Oak	Red Oak	White Oak			
<b>Color and Matching</b>									
Sapwood	No	No	5% <sup>a</sup>	Yes <sup>a</sup>	10-20% <sup>b</sup>	Yes	Yes	Yes	Yes
Heartwood	Yes	Yes	Yes	Yes	Yes	Yes	Yes	Yes	Yes
Color Streaks or Spots	Yes		Yes		Yes		Yes	Yes	Yes
Color Variation	Slight		Slight		Yes		Yes	Yes	Yes
Sharp Color Contrasts at Joints	Yes if Slip, Plank or Random matched		Yes if Slip, Plank or Random matched		Yes if Slip, Plank or Random matched		Yes	Yes	Yes
Type of Matching									
Book Matched	Yes		Yes		Specify		--	--	--
Slip Matched	Specify		Specify		Specify		--	--	--
Pleasant Matched	--		--		Yes		--	--	--
Nominal Minimum Width of Face Components <sup>c</sup>	Plain-S. Quar/Rift Rotary	6 in. 3 in. 6 in.	5 in. 3 in. 5 in.		3 in. 3 in. 4 in.		No Limit	No Limit	No Limit
<b>Natural Characteristics (Except as limited below, natural characteristics are not restricted.)</b>									
Inconspicuous Burls & Pin Knots – Combined Avg. Number	1 per 4 sq ft 8 per 4 ft x 8 ft panel		Yes; blending		Yes; blending		No Limit	No Limit	No Limit
Conspicuous Burls – Max. Size	¼ in.		3/8 in.		½ in.		No Limit	No Limit	No Limit
Conspicuous Pin Knots Avg. Number Max. Size: Dark Part Total	No		1 per 3 sq ft 10 per 4 x 8 ft panel 1/8 in. ¼ in.		1 per 2 sq ft 16 per 4 x 8 ft panel 1/8 in. ¼ in.		No Limit	No Limit	No Limit
Scattered Sound and Repaired Knots – Combined Avg. Number Max. Size – Sound Max. Size – Repaired Avg. No. – Repaired	No		No		1 per 8 sq ft 4 per 4 x 8 ft panel 3/8 in. 1/8 in. 1 per 8 sq ft		1 per 4 sq ft 8 per 4 x 8 ft panel ½ in. ½ in. 1 per 8 sq ft	1 per 3 sq ft 10 per 4 x 8 ft panel 1 in. ¾ in. 1 per 6 sq ft	No Limit 1 ½ in. 1 in. 1 per 2 sq ft
Mineral Streaks	No		Blending		1 row unlimited up to 12 in. long		Yes	Yes	Yes
Bark Pockets	No		No		Few to 1/8 in. x 1 in.		Few to ¼ in. x 2 in.	¼ in. x 2 in.	Yes
Worm Tracks	No		No		Slight		Few	Yes	Yes
Vine Marks	No		Slight		Yes		Yes	Yes	Yes
Cross Bars	Slight		Slight		Yes		Yes	Yes	Yes
<b>Manufacturing Characteristics</b>									
Rough Cut / Ruptured Grain	No		No		Slight		Slight	Two 8 in. diameter areas or equivalent	5% of panel
Blended Repaired Tapering Hairline Splits	Two 1/32 in. x 3 in. on panel ends only		Two 1/16 in. x 6 in.		Four 1/8 in. x 8 in.		Four 3/16 in. x 8 in.	Six ¼ in. x 10 in.	Yes
Repairs	Very Small Blending		Small Blending		Blending		Yes	Yes	Yes
<b>Special Characteristics (Except as limited below, special natural characteristics are not restricted.)</b>									
Ray Fleck <sup>d</sup>	Slight, Blending		Slight, Blending		Slight, Blending		Yes	Yes	Yes
Rift and Comb Grain	Rift permits 1 inch in 12 inches maximum grain slope, 2 ½ inches in 12 inches maximum grain sweep, fleck not to exceed 3/8 inch in width. Comb permits ½ inch in 12 inches maximum grain slope, ½ inch in 12 inches maximum grain sweep, fleck not to exceed 3/32 inch in width.								

Unfilled wormholes, open splits, open joints, open bark pockets, or doze not allowed in above grades.

<sup>a</sup> Sap allowed in rotary-cut only unless otherwise specified. <sup>b</sup> 10% Sap allowed in rift, comb, quarter-cut and plain-sliced; 20% sap allowed in rotary-cut.<sup>c</sup> Outside components will be a different size to allow for edge trim loss and certain types of matching. <sup>d</sup> Unless otherwise specified, quartered permits unlimited fleck.



**TABLE 3.4b – SUMMARY OF HARDWOOD FACE GRADE CHARACTERISTICS – Pecan and Hickory –****INCH-POUND**

NOTE: Because of the inherent individuality of trees, consideration should be given to the overall appearance of the veneer face to determine the appropriate grade for that veneer.

Cut		Plain-Sliced (Flat-Cut), Quarter-Cut, Rotary-Cut – See Table 2 for Common Face Veneer Patterns				
Grade Description		AA	A	B	C	1 (Back)
<b>Color and Matching</b>						
Sapwood		Yes	Yes	Yes	Yes	Yes
Heartwood		Yes	Yes	Yes	Yes	Yes
Color Streaks or Spots		Yes	Yes	Yes	Yes	Yes
Color Variation		Yes	Yes	Yes	Yes	Yes
Sharp Color Contrasts at Joints		Yes if Slip, Plank or Random matched	Yes if Slip, Plank or Random matched	Yes if Slip, Plank or Random matched	Yes	Yes
Type of Matching						
Book Matched		Yes	Yes	Specify	--	--
Slip Matched		Specify	Specify	Specify	--	--
Pleasant Matched		--	--	Yes	--	--
Nominal Minimum Width of Face Components <sup>a</sup>	Plain-S.	6 in.	5 in.	3 in.	No Limit	No Limit
	Quarter	3 in.	3 in.	3 in.		
	Rotary	6 in.	5 in.	4 in.		
<b>Natural Characteristics (Except as limited below, natural characteristics are not restricted.)</b>						
Inconspicuous Burls & Pin Knots – Combined Avg. Number		1 per 1 sq ft 32 per 4 x 8 ft panel	2 per 1 sq ft 64 per 4 x 8 ft panel	No Limit	No Limit	No Limit
Conspicuous Burls – Max. Size		1/4 in.	3/8 in.	1/2 in.	No Limit	No Limit
Conspicuous Pin Knots <sup>b</sup>						
Avg. Number		1 per 2 sq ft 16 per 4 x 8 ft panel	2 per 1 sq ft 64 per 4 x 8 ft panel	No Limit	No Limit	No Limit
Max. Size: Dark Part		1/8 in.	1/8 in.	1/8 in.		
Total		1/4 in.	1/4 in.	1/4 in.		
Scattered Sound and Repaired Knots – Combined Avg. Number		No	No	1 per 8 sq ft 4 per 4 x 8 ft panel	1 per 3 sq ft 10 per 4 x 8 ft panel	1 per 4 sq ft 8 per 4 x 8 ft panel
Max. Size – Sound				3/8 in.	1/2 in.	3/8 in.
Max. Size – Repaired				1/8 in.	1/2 in.	1/8 in.
Avg. No. – Repaired				1 per 8 sq ft	1 per 6 sq ft	1 per 4 sq ft
Mineral Streaks		Slight	Slight	Yes	Yes	Yes
Bark Pockets		No	Small, Occasional	Few to 1/4 in. x 2 in.	Few to 3/8 in. x 4 in.	Few to 3/8 in. x 4 in.
Worm Tracks		No	Slight	Few	Yes	Yes
Vine Marks		Slight	Occasional	Yes	Yes	Yes
Cross Bars		Slight	Occasional	Yes	Yes	Yes
<b>Manufacturing Characteristics</b>						
Rough Cut / Ruptured Grain		No	No	Slight	Two 8 in. dia. areas or equivalent	Two 8 in. dia. areas or equivalent
Blended Repaired Tapering Hairline Splits		Two 1/32 in. x 3 in. on panel ends only	Two 1/16 in. x 6 in.	Four 1/8 in. x 8 in.	Four 3/16 in. x 8 in.	Four 3/16 in. x 8 in.
Repairs		Very Small Blending	Small Blending	Blending	Yes	Yes
<b>Special Characteristics (Except as limited below, special natural characteristics are not restricted.)</b>						
Bird Peck <sup>c</sup>		No	Slight	Yes	Yes	Yes
Knife Marks		Knife marks may occur in these high-density species.				
Quartered		1 inch in 12 inches maximum grain slope, 2 1/2 inches in 12 inches maximum grain sweep				

Unfilled wormholes, open splits, open joints, open bark pockets, or doze not allowed in above grades.

<sup>a</sup> Outside components will be a different size to allow for edge trim loss and certain types of matching. <sup>b</sup> For pecan and hickory, conspicuous pin knots means sound knots 1/4 inch or less in diameter with dark centers larger than 1/16 inch. Blending pin knots are sound knots 1/4 inch or less in diameter with dark centers 1/16 inch or less and are allowed in all grades of pecan and hickory.<sup>c</sup> To achieve a more rustic appearance, bird peck shall be specified.

**TABLE 3.5b – SUMMARY OF HARDWOOD FACE GRADE CHARACTERISTICS – Walnut and Cherry –****INCH-POUND**

NOTE: Because of the inherent individuality of trees, consideration should be given to the overall appearance of the veneer face to determine the appropriate grade for that veneer.

Cut		Plain-Sliced (Flat-Cut), Quarter-Cut, Rotary-Cut – See Table 2 for Common Face Veneer Patterns					
Grade Description		AA	A	B	C	D	E
<b>Color and Matching</b>							
Sapwood		No	No <sup>a</sup>	No <sup>a</sup>	Yes	Yes	Yes
Heartwood		Yes	Yes	Yes	Yes	Yes	Yes
Color Streaks or Spots		Slight	Slight	Yes	Yes	Yes	Yes
Color Variation		Slight	Slight	Yes	Yes	Yes	Yes
Sharp Color Contrasts at Joints		Yes if Slip, Plank or Random matched	Yes if Slip, Plank or Random matched	Yes if Slip, Plank or Random matched	Yes	Yes	Yes
Type of Matching							
Book Matched		Yes	Yes	Specify	--	--	--
Slip Matched		Specify	Specify	Specify	--	--	--
Pleasing Matched		--	--	Yes	--	--	--
Nominal Minimum	Plain-S.	6 in.	5 in.	3 in.			
Width of	Quarter	3 in.	3 in.	3 in.	No Limit	No Limit	No Limit
Natural Components <sup>b</sup>	Rotary	6 in.	5 in.	4 in.			
<b>Natural Characteristics (Except as limited below, natural characteristics are not restricted.)</b>							
Inconspicuous Burls & Pin Knots – Combined Avg. Number		1 per 4 sq ft 8 per 4 x 8 ft panel	1 per 1 1/3 sq ft 24 per 4 x 8 ft panel	2 per 1 sq ft 64 per 4 x 8 ft panel	No Limit	No Limit	No Limit
Conspicuous Burls – Max. Size		1/4 in.	3/8 in.	1/2 in.	No Limit	No Limit	No Limit
Conspicuous Pin Knots <sup>c</sup>							
Avg. Number		1 per 5 sq ft 6 per 4 x 8 ft panel	1 per 2 sq ft 16 per 4 x 8 ft panel	1 per 1 sq ft 32 per 4 x 8 ft panel	No Limit	No Limit	No Limit
Max. Size: Dark Part		1/8 in.	1/8 in.	1/8 in.			
Total		1/4 in.	1/4 in.	1/4 in.			
Scattered Sound and Repaired Knots – Combined Avg. Number		No	No	1 per 8 sq ft 4 per 4 x 8 ft panel	1 per 4 sq ft 8 per 4 x 8 ft panel	1 per 3 sq ft 10 per 4 x 8 ft panel	No Limit
Max. Size – Sound				3/8 in.	1/2 in.	1 in.	1 1/2 in.
Max. Size – Repaired				1/8 in.	1/2 in.	3/4 in.	1 in.
Avg. No. – Repaired				1 per 8 sq ft	1 per 8 sq ft	1 per 6 sq ft	1 per 2 sq ft
Mineral Streaks		Slight	Slight	Yes	Yes	Yes	Yes
Bark Pockets		No	No	Few to 1/8 in. x 1 in.	Few to 1/4 in. x 2 in.	1/4 in. x 2 in.	Yes
Worm Tracks		No	No	Slight	Few	Yes	Yes
Vine Marks		Slight	Occasional	Yes	Yes	Yes	Yes
Cross Bars		Slight	Occasional	Yes	Yes	Yes	Yes
<b>Manufacturing Characteristics</b>							
Rough Cut / Ruptured Grain		No	No	Slight	Slight	Two 8 in. dia. areas or equivalent	5% of panel
Blended Repaired Tapering Hairline Splits		Two 1/32 in. x 3 in. on panel ends only	Two 1/16 in. x 6 in.	Four 1/8 in. x 8 in.	Four 3/16 in. x 8 in.	Six 1/4 in. x 10 in.	Yes
Repairs		Very Small Blending	Small Blending	Blending	Yes	Yes	Yes
<b>Special Characteristics (Except as limited below, special natural characteristics are not restricted.)</b>							
Gum Spots		Occasional gum spots in cherry	Occasional gum spots in cherry	Gum spots and gum streaks in cherry	Gum spots and gum streaks in cherry		
Quartered		1 inch in 12 inches maximum grain slope, 2 1/2 inches in 12 inches maximum grain sweep					

Unfilled wormholes, open splits, open joints, open bark pockets, or doze not allowed in above grades.

<sup>a</sup> Sap is allowed in grades A and B; however, the percentage must be agreed upon between buyer and seller. <sup>b</sup> Outside components will be a different size to allow for edge trim loss and certain types of matching. <sup>c</sup> For walnut and cherry, conspicuous pin knots means sound knots 1/4 inch or less in diameter with dark centers larger than 1/16 inch. Blending pin knots are sound knots 1/4 inch or less in diameter with dark centers 1/16 inch or less and are allowed in all grades of walnut and cherry.

TABLE 4 – HARDWOOD DOOR FACE GRADE CHARACTERISTICS

Grade Description		AA	A	B
Nominal Minimum Width of Face Components <sup>a</sup>	Plain-Sliced	127 mm (5 in.)	102 mm (4 in.)	76 mm (3 in.)
	Quartered / Rift	76 mm (3 in.)	76 mm (3 in.)	76 mm (3 in.)
	Rotary-Cut	127 mm (5 in.)	102 mm (4 in.)	102 mm (4 in.)
Grade characteristics for color and matching, natural, manufacturing, & special characteristics are as specified in TABLES 3.1 – 3.5				

<sup>a</sup> Outside components will be a different size to allow for edge trim loss and certain types of matching.

**TABLE 5 – SUMMARY OF HARDWOOD FACE AND BACK GRADE CHARACTERISTICS – Western Red Alder  
METRIC AND INCH-POUND**

Cut	Rotary and Sliced			
	A	B	C / Rustic	1 (Back)
<b>Color and Matching</b>				
Sapwood	Yes	Yes	Yes	Yes
Heartwood	Yes	Yes	Yes	Yes
Color Streaks	Slight	Slight	Yes	Yes
Color Variation	Slight	Slight	Yes	Yes
Nominal Minimum Width of Face Components	76 mm (3 in.)	76 mm (3 in.)	76 mm (3 in.)	No minimum
Type of Matching Plank Matched for pleasing appearance	Yes <sup>a</sup>	Yes <sup>a</sup>	Yes <sup>a</sup>	Any matching type at the option of the mill
Book Matched – Matched for color and grain at the joints	Specify	Specify <sup>b</sup>	Specify	
<b>Natural Characteristics</b>				
Conspicuous Burls – Max. Size	12.7 mm (1/2 in.)	Yes	Yes	Yes
Pin Knots	Yes	Yes	Yes	Yes
Bark Pockets	No	Few	Unlimited in number	Few
		Maximum Size 6.4 mm x 50.8 mm (1/4 in. x 2 in.)	Maximum size (6.4 mm x 102 mm) (1/4 in. x 4 in.)	Maximum size 6.4 mm x 50.8 mm (1/4 in. x 2 in.)
Sound Knots <sup>b</sup> – Max. Size (may contain dark centers)	12.7 mm (1/2 in.)	50.8 mm (2 in.)	Yes	Yes
Repaired Knot Holes <sup>b</sup> – Number; Maximum Size	Two; 6.4 mm (1/4 in.) Max. Dia.	Six; 19 mm (3/4 in.) Max. Dia.	Unlimited; 38 mm (1 1/2 in.) Max. Dia.	Sixteen; 19 mm (3/4 in.) Max. Dia.
<b>Manufacturing Characteristics</b>				
Rough Cut	No	Small Areas Allowed	Small Areas Allowed	Small Areas Allowed
Stain	No	Slight	Yes	Yes
Blended Repaired Tapering Hairline Splits	Two 1.6 mm x 152 mm (1/16 in. x 6 in.) on panel ends	Three 3.2 mm x 254 mm (1/8 in. x 10 in.) on panel ends	3.2 mm x 305 mm (1/8 in. x 12 in.)	3.2 mm x 305 mm (1/8 in. x 12 in.)
Repairs	Blending	Blending	Yes	Yes
Special Characteristics	–	Open Knots <sup>b</sup>	–	–

<sup>a</sup> The general color of individual components shall not be significantly lighter or darker than that of other components in the face.

<sup>b</sup> Book Matched Grade B – One row of unlimited 3/4-inch open knots is allowed.

TABLE 6 – SUMMARY OF DECORATIVE SOFTWOOD GRADE CHARACTERISTICS - Investigation -

METRIC AND INCH-POUND

Cut	DECORATIVE KNOTTY SOFTWOOD FACE AND BACK GRADE CHARACTERISTICS WESTERN RED CEDAR AND WHITE PINE			VERTICAL GRAIN SOFTWOOD FACE GRADE CHARACTERISTICS DOUGLAS FIR AND REDWOOD	
	Rotary and Sliced Knotty Veneer			Sliced – Vertical Grain	
	Grade Description	A (Face)	B (Face)		A (Face) <sup>a</sup>
Red Cedar			White Pine	1 (Back) <sup>a</sup> / C (Face)	Douglas fir
<b>Color and Matching</b>					
Sapwood	Yes	Yes	Yes	Blending	Yes
Heartwood	Yes	Yes	Yes	Yes <sup>b</sup>	
Color Streaks	Slight	Yes	Yes	Slight	
Color Variation	No	Slight	Yes	Slight	
Stain, Blue and Brown	No	Slight	Yes	No	
Type of Matching:					
Book Matched for color and grain at the joints	--	--	--	Yes <sup>c</sup>	
Plank Matched for pleasing appearance	Yes	Yes	Not Applicable	Yes <sup>c</sup>	
<b>Natural Characteristics</b>					
Burls	Yes	Yes	Yes	Small	
Pin Knots	Yes	Yes	Yes	Blending, 1 Row	Yes
Sound Knots; Max. Size	50.8 mm (2 in.)	89 mm (3 1/2 in.)	Yes	No	
Spike Knots; Max. Size	50.8 mm (2 in.)	89 mm (3 1/2 in.)	Yes	No	
Repaired Knot Holes; Max. Size	19 mm (3/4 in.)	38 mm (1 1/2 in.)	Unlimited	No	
Pitch Streaks	Small	Small	Yes	Blending	No
Pitch Pockets	Few to 3.2 mm x 25.4 mm (1/8 in. x 1 in.)	Few to 3.2 mm x 50.8 mm (1/8 in. x 2 in.)	Yes	No	
Crows Foot	Slight	Occasional	Yes	No	
<b>Manufacturing Characteristics</b>					
Rough Cut	No	Slight	Yes	Slight	
Blended Repaired Tapering Hairline Splits	Yes	Yes	Yes <sup>b</sup>	Yes	
Repairs	Blending	Blending	Yes	Blending	
<b>Special Characteristics</b>					
Cross Bars	--	--	--	No	
	Unfilled wormholes, open splits, open joints, ruptured grain, or doze not allowed in grades A and B. <sup>a</sup> All knotty western red cedar and white pine complying with this Standard shall meet these back grade requirements unless otherwise specified. <sup>b</sup> Open hairline checks and splits up to 305 mm (12 in.) long and 3.2 mm (1/8 in.) wide allowed.			Unfilled wormholes, open splits, open joints, ruptured grain, or doze not allowed. <sup>a</sup> See Table 7 for description of back grades. <sup>b</sup> Heartwood must have 6 or more annual rings per 25.4 mm (1 inch). <sup>c</sup> Shall be provided book matched unless otherwise specified.	

**3.3.6 GRADE D** – Requirements for grade D faces appear in Tables 3.1a through 3.5b. This grade allows unlimited color streaks and spots, and color variation. An unlimited number of small burls and pin knots are allowed with no restrictions on the size of dark pin knot centers as long as the diameter of pin knots does not exceed 6.4 mm (1/4 inch) in diameter. The size of repaired and sound knotholes and similar shaped openings shall not exceed 19 mm (3/4 inch) for repaired and 25.4 mm (1 inch) for sound knots with a specified number based on individual species. Grade D faces shall provide a sound face, free of open defects. The size or percentage of rough grain on the panel surface depends on the species (see Tables 3.1a through 3.5b).

**3.3.7 GRADE E** – Requirements for grade E faces appear in Tables 3.1a through 3.5b. The grade allows unlimited color streaks and spots, color variation, and an unlimited number of small burls, pin knots, repaired openings, and sound knots. Repaired knotholes and similar shaped openings shall not exceed 25.4 mm (1 inch) in diameter and sound knot size is restricted to 38 mm (1 1/2 inches) in diameter. Grade E faces shall provide a sound face, free of open defects. The maximum amount of rough-cut veneer shall be in accordance with Tables 3.1a through 3.5b.

**3.3.8 RUSTIC GRADE (R)** – Rustic grade will include well scattered natural characteristics in both sliced and rotary-cut veneer faces as agreed upon between buyer and seller.

**3.3.9 SPECIALTY GRADE (SP)** – This grade shall be applicable instead of grades AA, A, B, C, D and E only to veneer in which the features of greatest significance are unusual characteristics, component widths that are not described by the above-mentioned grades, or proprietary to the manufacturer. Characteristics shall be as agreed upon between buyer and seller. This grade also refers to sound faces with large wood repairs such as boat patches. This category also includes wall panel face veneers and engineered veneer. Species such as wormy chestnut, birds-eye maple, and English brown oak which have unusual decorative features are considered as Specialty Grade.

**3.3.10 SOFTWOOD GRADES** – Tables 6 contain the face veneer grade requirements for specific knotty and vertical grain decorative softwoods. Requirements for unlisted softwoods for faces shall be selected by buyer and seller from among those listed in Tables 3.1a through 3.5b or Table 6. The type of matching for unlisted softwood faces shall be agreed to by buyer and seller. Softwoods for backs and inner plies shall meet the grading requirements of Table 7 and 8.

**3.3.11 RECONSTITUTED VENEER** – Hardwood Plywood may be produced using reconstituted veneers for the decorative face or back. Reconstituted veneers are typically produced using species such as obeche (ayous), poplar, basswood or other abundant and rapidly growing “white” hardwood species. These logs are typically rotary peeled into thin veneers, which are bleached and then dyed to a desired color. The resulting veneers are then glued and pressed to form

solid blocks, which are then sliced across the glue lines to create veneers with consistent grain and color appearance. Color and grain appearance may be similar to some natural wood species, but these reconstituted veneers are not typically made from the species with which they may share visual similarities.

It is common industry practice to advertise the sale of decorative plywood made with a reconstituted veneer face based on its appearance in relation to a natural wood species (e.g. cherry, walnut, etc.). This is not intended to suggest that the reconstituted veneer is made from that species, or with any specific grade, cut, or grain characteristics as may be described for a natural wood veneer. To ensure clarity and avoid complications with U.S. federal law, such panels shall clearly indicate their use of reconstituted veneer by including a term such as “recon,” “reconstituted,” “engineered,” or other similar descriptor before the “species” listed on product labeling and in marketing materials. For example, a reconstituted veneer made from obeche through the process described above may be described as “Recon Quartered Teak.” This ensures that the end user understands the veneer is reconstituted, and that the description is not to imply it is a natural wood quarter sliced teak. To comply with U.S. federal law, it is also highly encouraged to communicate to customers the actual wood species used to produce the reconstituted veneer prior to purchase.

**3.4 BACK GRADES** – The summary of characteristics and allowable defects for four back grades are shown in Table 5 and Table 7. Back grades are designated by numbers: 1, 2, 3, and 4. Requirements of grade 1 are most restrictive, with grades 2, 3, and 4 being progressively less restrictive. Grades 1 and 2 provide sound surfaces with all openings in the veneer repaired except for vertical wormholes not larger than 1.6 mm (1/16 inch). Grades 3 and 4 permit some open defects; however, grade 3 is obtainable with repaired splits, joints, bark pockets, laps, and knotholes to achieve a sound surface if specified by the buyer. Grade 4 permits knotholes up to 102 mm (4 inches) in diameter and open splits and joints limited by width and length. Descriptions of the back grades for red alder and knotty softwoods appear in Tables 5 and 6, respectively. Method of cut and matching may be different from that of the panel face unless agreed to between buyer and seller.

**3.5 INNER PLY GRADES** – Inner plies are limited by the diameters and widths of openings listed in Table 8 and other provisions stated in Tables 9a and 9b. Four grades are described with the following designations: J, K, L, and M. Grade J is the most restrictive, allowing minimal size openings. Grades K, L, and M are progressively less restrictive. The least restrictive grade (M) is for plies not adjacent to faces and allows round and similar shaped openings not to exceed 63.5 mm (2 1/2 inches) and elongated openings up to 25.4 mm (1 inch) as visible on the edges or ends of panels.

**3.6 THICKNESS OF VENEERS** – Minimum acceptable thicknesses of veneers vary with the intended use and species and have no fixed limits except as agreed upon by the buyer and

seller. Decorative plywood face veneers are cut at different thicknesses, generally 0.65 mm (1/38", 0.026") and thinner.

**Note:** tolerance is measured prior to manufacturer's sanding.

**3.7 LUMBER CORES** – Lumber cores shall be of any listed species, except that mixing of species in a single core is prohibited. The maximum permissible width of core strips shall be 76 mm (3 inches) for Category A and B species (see Table 1), and 102 mm (4 inches) for Category C and D species. Core grades and core banding requirements shall be as described in 3.7.1 through 3.7.5. Finished hardwood plywood manufactured using lumber core shall have a flat smooth surface free of warpage.

**3.7.1 CLEAR GRADE** – The wood strips shall be full length or finger-jointed and shall be free of knots or other defects which will not properly shape or mold. Discolorations and wood repairs (patches, plugs and filler) are not prohibited.

**3.7.2 SOUND GRADE** – The wood strips shall be full length or finger-jointed and shall be free of defects, except discolorations and sound knots. Small open defects shall not be allowed unless securely repaired with wood or wood filler.

**3.7.3 REGULAR GRADE** – The wood strips shall be the same as sound grade, except that tightly butted ends are not prohibited.

**3.7.4 CLEAR EDGE** – The wood strips shall be "regular grade," except that the edge strips shall be a minimum of 38 mm (1 1/2 inches) "clear grade" to permit shaping or molding.

**3.7.5 BANDED CORE** – The bands shall be "clear grade." The species, width, number, and sequence of application of bands, and grade between bands shall be as agreed upon between buyer and seller. The types of banding shall be as follows:

1. Banded one end (B1E)
2. Banded two ends (B2E)
3. Banded one side (B1S)
4. Banded two sides (B2S)
5. Banded two ends and one side (B2E1S)
6. Banded two sides and one end (B2S1E)
7. Banded two sides and two ends (B4)

**3.8 PARTICLEBOARD (PB), FIBERBOARD (MDF), ORIENTED STRAND BOARD (OSB) AND HARDBOARD CORES** – Cores shall be in accordance with ANSI A208.1-2022 Particleboard, ANSI A208.2-2022 Medium Density Fiberboard, APA PS-2 Oriented Strand Board, and ANSI A135.4-2012 (R2020) Basic Hardboard.<sup>5</sup>

**3.9 SPECIAL CORES** – Cores made of other material shall be allowed if all other applicable requirements of this Standard are met.

**3.10 CONSTRUCTION** – Any combination of plies consistent with the definition of hardwood plywood shall be acceptable. Bonded assemblies are typically constructed utilizing combinations of species, thickness and moisture content to produce a balanced panel. Most plywood panels achieve balance by being constructed with an odd number of plies where all inner plies, except the innermost ply, occur in pairs. Some constructions utilize an even number of plies: constructions that contain layers of adjacent veneers with parallel grain; two-ply door skin constructions, in which the grain of veneer plies is perpendicular; or constructions in which decorative veneer is bonded to one side of particleboard, medium density fiberboard, or hardboard. A ply shall consist of a single veneer, particleboard, medium density fiberboard (MDF), hardboard, or lumber. Typical constructions are illustrated in Figure 2. The limiting criteria for hardwood plywood shall be as provided in Table 9a and 9b (see 3.17 for marking).

**3.10.1 SPECIAL CONSTRUCTION** – Because of special panel constructions and because of special face treatments, certain panels for specific applications, e.g. two-ply door skins, thin wall panels, etc., are not required to have a flat surface prior to their application. Such deviation shall not prevent their taking the shape of the surface to which they are applied without the development of defects attributable to this deviation.

<sup>5</sup> Later issues of these publications may be used provided the requirements are applicable and consistent with the issue designated. Copies are available from the Composite Panel Association at [www.compositepanel.org](http://www.compositepanel.org).

**TABLE 7 – SUMMARY OF ALLOWABLE NATURAL CHARACTERISTICS FOR BACK GRADES  
METRIC AND INCH-POUND**

Grade Description	1	2	3	4
Sapwood	Yes	Yes	Yes	Yes
Discoloration & Stain	Yes	Yes	Yes	Yes
Mineral Streaks	Yes	Yes	Yes	Yes
Sound Tight Burls	Yes	Yes	Yes	Yes
Sound Tight Knots	Max. dia. 9.5 mm (3/8 in.)	Max. dia. 19 mm (3/4 in.)	Max. dia. 38 mm (1 ½ in.)	Yes
Maximum Number of Tight Knots	16	16	Unlimited to 12.7 mm (½ in.); No more than 16 from 12.7 mm to 38 mm (½ to 1 ½ in.)	Unlimited
Knotholes	6 Max. dia. 3.2 mm (1/8") repaired	12.7 mm (½ in.) repaired	25.4 mm <sup>c</sup> (1 in.) <sup>c</sup>	102 mm (4 in.)
Maximum Combined Number of Knotholes and Repaired Knots	None <sup>a</sup>	All repaired; Unlimited to 9.5 mm (3/8 in.); No more than 8 from 9.5 mm to 12.7 mm (3/8 in. to ½ in.)	Unlimited to 9.5 mm (3/8 in.); No more than 10 from 9.5 mm to 25.4 mm <sup>c</sup> (3/8 in. to 1 in.) <sup>c</sup>	Unlimited
Wormholes	Filled <sup>b</sup>	Filled <sup>b</sup>	Yes	Yes
Splits or Open Joints	Six 3.2 mm x 305 mm (1/8 in. to 12 in.) repaired	Six 4.8 mm x 305 mm (3/16 in. x 12 in.) repaired	Yes, 9.5 mm (3/8 in.) by 1/4 length of the panel <sup>c</sup>	25.4 mm (1 in.) for 1/4 length of the panel; 12.7 mm (1/2 in.) for ½ length of the panel; 6.4 mm (1/4 in.) for full length of panel
Doze and Decay	Firm areas of doze	Firm areas of doze	Firm areas of doze	Areas of doze and decay provided serviceability of panel is not impaired
Rough Cut/Ruptured Grain	Two 203 mm (8 in.) diameter areas	5% of panel	Yes	Yes
Bark Pockets	3.2 mm (1/8 in.) wide repaired <sup>d</sup>	6.4 mm (1/4 in.) wide repaired	Yes <sup>c</sup>	Yes
Laps	No	Repaired	Yes <sup>c</sup>	Yes

Back is the unexposed surface of a panel or the second (least important decoratively) surface when both surfaces are exposed. Ordering a back grade for both surfaces shall be permitted when agreed upon between buyer and seller.

<sup>a</sup> Repaired pin knots and pin knots allowed.

<sup>b</sup> Unfilled wormholes shall be a maximum of 1.6 mm in diameter.

<sup>c</sup> Available repaired, if specified.

<sup>d</sup> For pecan and hickory: 9.6mm (3/8 in.) wide repaired.



TABLE 8 – SUMMARY OF ALLOWABLE OPENINGS FOR INNER PLY GRADES OF CORE VENEER<sup>a</sup>

METRIC AND INCH-POUND

Grade Description	Grade Designation				
	J	K		L	M
Thickness of Crossbands Adjacent to Faces	Any thickness	Thicker than 2.5 mm (1/10 in.)	2.5 mm (1/10 in.) and thinner	Any thickness	Not applicable
Knotholes and Other Round, Elliptical, or Similar Shape Openings (Max. Diameter)	None	9.5 mm (3/8 in.)	19 mm (3/4 in.)	25.4 mm (1 in.)	63.5 mm (2 1/2 in.)
Splits, Gaps, and Other Elongated End or Edge Openings – Each Opening is Visible on Only One End or Edge of Panel (Max. Width)	3.2 mm (1/8 in.)	6.4 mm (1/4 in.)		12.7 mm (1/2 in.)	25.4 mm (1 in.)

<sup>a</sup> Inner ply grades are also limited by characteristics listed in footnotes c and d of Table 9a depending on face grade and bond line type.

Figure 2 – Typical Plywood Constructions and Properties Comparison\*

Veneer Core Plywood

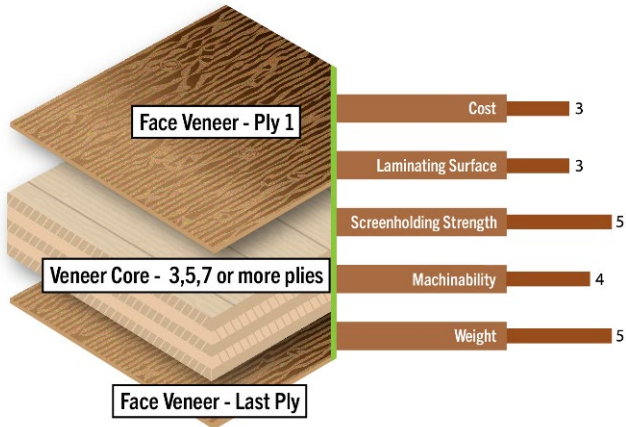

Particleboard Core Plywood

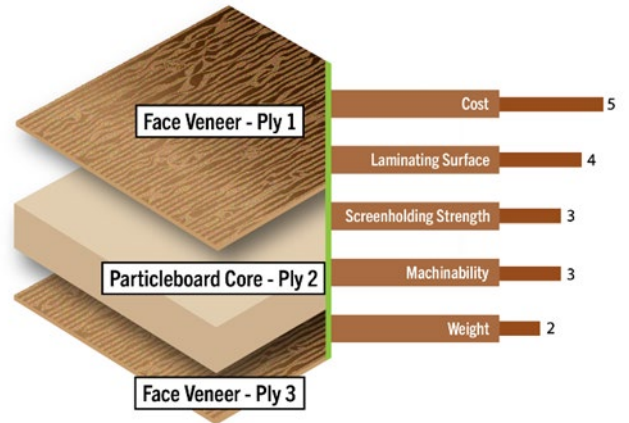

Combination Core Plywood with Composite Crossbands

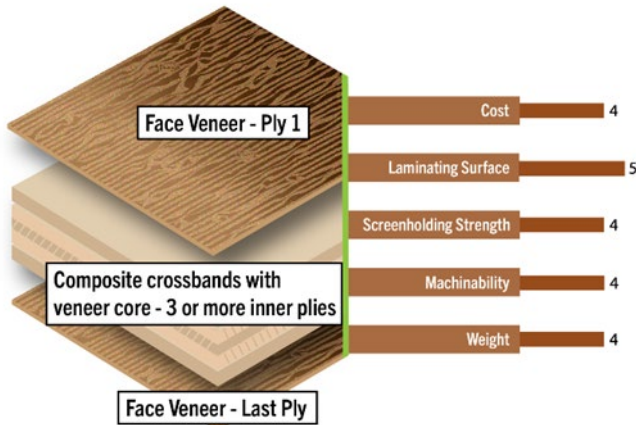

Oriented Strand Board (OSB) Core Plywood

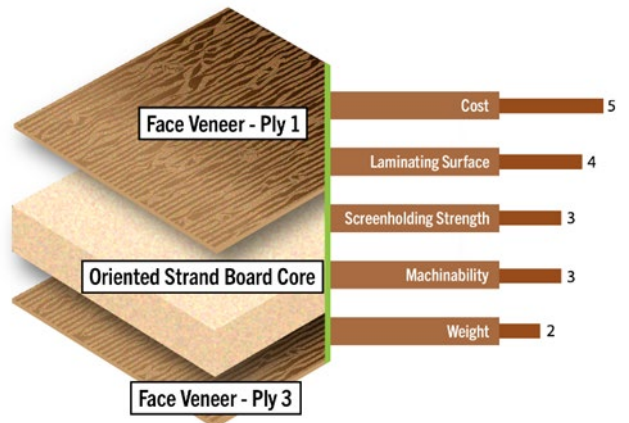

Medium Density Fiberboard Core Plywood

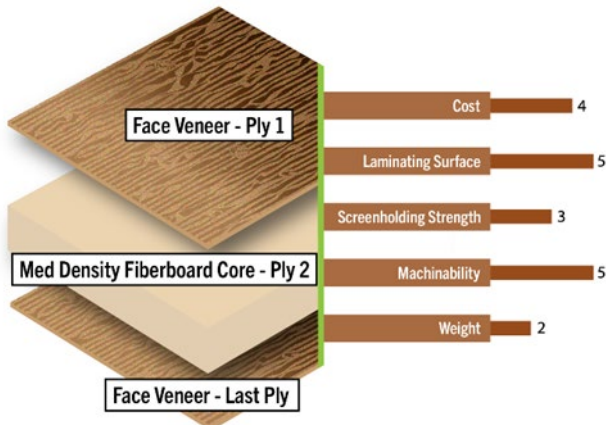

\*Note: Not all possible constructions are represented.

Source: Timber Products Company

1 = POOR    2 = BELOW AVERAGE    3 = AVERAGE    4 = ABOVE AVERAGE    5 = EXCELLENT

TABLE 9a – LIMITING CRITERIA FOR PLYWOOD Barcode:4763907-02 C-552-852 INV - Investigation -

Limiting Factors <sup>a</sup>	Technical (Exterior)	Type I <sup>a</sup> (Exterior)	Type II (Interior)
Species or Categories of Core Veneer (3.2)	Specify	Specify	Specify
Core Veneer Edge Joints (3.3)	No tape	No tape	Tape permitted
Grade of Face Veneers (3.3)	Specify among AA, A, or B	Specify	Specify
Grade of Back Veneers (3.4)	Specify	Specify	Specify
Grade and Limitations of Inner Plies Adjacent to Faces (3.5) <sup>a</sup>	J <sup>b</sup> under AA, A, and B	K <sup>c</sup>	K <sup>d</sup> under AA, A, or B L <sup>d</sup> under C, D, or E Specify under specialty and rustic grades
Grade of Other Inner Plies (3.5) <sup>a</sup>	K <sup>c</sup> or better	M or better	M or better
Grade of Lumber Core (3.7)	Not suitable	Specify	Specify
Particleboard, MDF, and Hardboard Cores (3.8)	Not suitable	Not suitable	Specify

<sup>a</sup> If the buyer requires a specific inner ply grade among those listed in Table 8, it must be specified. Shall not be used when continuously exposed to moisture in critical use applications such as for marine and aircraft.

<sup>b</sup> Patches and gum spots are not prohibited. Sound tight knots shall not exceed 19 mm (3/4 inch). No unfilled wormholes, cross breaks, ruptured grain, bark pockets, brashness, or laps permitted.

<sup>c</sup> No brashness permitted. Cross breaks, ruptured grain, doze, and other characteristics are allowed only as long as serviceability of panel is not impaired.

<sup>d</sup> For Type II plywood, inner ply grades limited only by allowable opening sizes in Table 8. Where 1.6 mm (1/16 inch) or thicker faces are used, Grade M inner plies are allowed.

TABLE 9b – PERFORMANCE CRITERIA FOR PLYWOOD

METRIC AND INCH-POUND

Limiting Factors	Technical (Exterior)	Type I <sup>a</sup> (Exterior)	Type II (Interior)
Bond Line Requirements (See Section 3.11)	Fully waterproof	Fully waterproof	Water resistant
Bond Line (glue bond) Test Performance (See Section 3.11)	<u>Dry and cyclic-boil shear</u>	<u>Dry and cyclic-boil shear</u>	<u>Three-cycle soak and dry</u>
Softwood Core	Section 4.3 and PS 1-19 exterior plywood	Section 4.3 and PS 1-19 exterior plywood	All Type II require Section 4.6
Other Core	Sections 4.3,4.4,4.5	Sections 4.3,4.4,4.5	
Formaldehyde Emissions Requirements (See Section 3.12)	Maximum Large Scale Chamber Concentration (ASTM E 1333 <sup>6</sup> or ASTM D6007 <sup>6</sup> )		
	Level 2 Level 2 NAF, ULEF Exempt	<u>mg/m<sup>3</sup></u> 0.06 0.05/0.06	<u>ppm</u> 0.05 0.04/0.05
Tolerances for Width and Length (See Section 3.13)	+/- 0.8 mm (1/32 in. or 0.031 in.)		
NOMINAL: Thickness Class Designations (See Section 3.13)	<u>Designations shall NOT be expressed in terms of actual units of measure</u>		
Fractional Class	3/4, 5/8, 1/2, 3/8, 1/4, 3/16, or 1/8 Class		
Decimal Class	.750, .625, .500, .375, .250, .185, or .125 Class		
Metric Class	19.2, 15.9, 12.7, 9.5, 6.4, 4.8, or 3.2 Class		
ACTUAL: Thickness for Class Designations must be provided (See Section 3.13)	<u>Minimum Allowable Thickness of Stated Class</u>		
Greater or equal to: 1/4, .250, 6.4	- 3/64 in., .047 in., or 1.2 mm		
Less than: 1/4, .250, 6.4	- 1/32 in., .031 in., or 0.8 mm		
Squareness (See Section 3.13.1)	Square within 2.4 mm (3/32 in. or 0.094 in.) for Panels > 1219 mm by 1219 mm (4 ft. by 4 ft.) Square within 1.6 mm (1/16 in. or 0.063 in.) for Panels ≤ 1219 mm by 1219 mm (4 ft. by 4 ft.)		
Straightness (See Section 3.13.2)	Straight within 1.6 mm (1/16 in. or 0.063 in.) for Panels ≤ 2438 mm (8 ft.) Straight within 2.4 mm (3/32 in. or 0.094 in.) for Panels > 2438 mm (8 ft.)		
Sanding (See Section 3.14)	Specify		
Moisture Content (See Section 3.15)	< 12% leaving Mill		

<sup>a</sup> Shall not be used when continuously exposed to moisture in critical use applications such as for marine and aircraft.

<sup>6</sup> The latest issue of ASTM publications shall be used provided the requirements are applicable and consistent with the issues designated. ASTM publications may be purchased from ASTM International, 100 Barr Harbor Drive, PO Box C700, West Conshohocken, PA 19428-2959 USA, [www.astm.org](http://www.astm.org).

**TABLE 10 – WOOD FAILURE REQUIREMENTS FOR TECHNICAL AND TYPE I PLYWOOD BOND LINES**

Average Failing Load		Minimum Wood Failure	
		Individual Specimen	Test Piece Average
Kilopascals (kPa)	(lb./ sq. inch)	Percent <sup>a</sup>	Percent <sup>a</sup>
Under 1724	(Under 250)	25	50
1724-2413	(250-350)	10	30
Over 2413	(Over 350)	10	15

<sup>a</sup> These values are the percentage of wood area remaining adhered to the fractured surface in the test area.

### 3.11 BOND LINE AND RELATED REQUIREMENTS

#### 3.11.1 CONSTRUCTION REQUIREMENTS

Construction requirements specific to plywood types are specified in tables 9a and 9b.

**3.11.2 TECHNICAL & TYPE I PLYWOOD** – The bond line of Technical & Type I plywood panels shall meet the requirements given in Table 10 when tested in accordance with 4.2, 4.3, and 4.4.

**3.11.3 TYPE II PLYWOOD** – The bond line of Type II plywood shall be of such quality that specimens shall withstand the 3-cycle soak test and criteria described in 4.2.2 and 4.6.

**3.12 FORMALDEHYDE EMISSIONS** – Hardwood plywood shall be certified to or compliant with the California Air Resources Board Airborne Toxic Control Measure to Reduce Formaldehyde Emissions from Composite Wood Products (CARB), EPA TSCA Title VI 40 CFR Part 770 Formaldehyde Emission Standards for Composite Wood Products (TSCA), and Canada’s Formaldehyde Emissions from Composite Wood Products Regulations (CANFER). Panels or panel bundles shall be labeled in accordance with TSCA requirements, and may also be labeled in accordance with CARB and CANFER requirements at the manufacturer’s discretion.

Hardwood plywood manufacturers that apply veneer to a substrate (e.g. hardwood plywood, PB, MDF) and subsequently process those panels into “component parts” or “finished goods” as defined in TSCA Title VI shall comply with the TSCA requirements for “laminated product producers” and “fabricators.” Manufacturers that lay up their own hardwood plywood (e.g. line-by-line veneer core plywood construction) prior to subsequent processing into component parts or finished

goods shall require third party certification of the plywood as a “panel manufacturer” per TSCA requirements.

Prior to fabrication into component parts or finished goods, all hardwood plywood products shall comply with the CARB and TSCA formaldehyde emissions limit for hardwood plywood (0.05 ppm) and shall be tested according to the ASTM E1333<sup>7</sup> Standard Test Method for Determining Formaldehyde Concentrations in Air and Emission Rates from Wood Products using a Large Chamber, or equivalent ASTM D6007<sup>7</sup> Standard Test Method for Determining Formaldehyde Concentrations in Air from Wood Products Using a Small Scale Chamber. ASTM D6007<sup>7</sup> small chamber equivalency must be demonstrated per CARB and TSCA requirements.

**3.13 DIMENSIONS AND TOLERANCES** – The actual dimensions of hardwood plywood panels shall be as agreed upon between the buyer and the seller. The tolerances for the stated dimensions shall be as follows:

**Width:** Stated actual plus or minus 0.8 mm (1/32 inch or 0.031 inch)

**Length:** Stated actual plus or minus 0.8 mm (1/32 inch or 0.031 inch)

**Thickness:** (sanded or unsanded)

Thickness may be referred to and labeled as the “Thickness Class” but is not required. The Thickness Class designation shall NOT be expressed in terms of actual units of measurement.

Thickness Class designation, if used, shall be expressed as follows:

Fractional Class designation:  
(Examples: 3/4, 5/8, 1/2, 3/8, 1/4, 3/16, or 1/8 Class)

Decimal Class designation:  
(Examples: .750, .625, .500, .375, .250, .185, or .125 Class)

Metric Class designation:  
(Examples: 19.2, 15.9, 12.7, 9.5, 6.4, 4.8, or 3.2 Class)

The actual thickness shall at minimum be provided:

For Class designations equal to or greater than 1/4, .250 or 6.4 shall have a minimum thickness of stated Class designation with minus 3/64 inch, .047 inch, or 1.2 mm allowed.

For Class designations less than 1/4, .250 or 6.4 shall have a minimum thickness of stated Class designation minus 1/32 inch, .031 inch, or 0.8 mm allowed.

Actual thickness shall be measured to the nearest 0.025 mm (0.001 inch) using a dial thickness gauge or conventional micrometer. Sufficient pressure shall be applied to ensure that the anvils of the instrument are in firm and square contact with, but do not compress, the panel surface. One measurement shall be taken at approximate mid-width of one end of the panel. This

<sup>7</sup> The latest issue of ASTM publications shall be used provided the requirements are applicable and consistent with the issues designated. ASTM publications may be purchased from ASTM International, 100 Barr

Harbor Drive, PO Box C700, West Conshohocken, PA 19428-2959 USA, [www.astm.org](http://www.astm.org).

measurement shall represent the panel thickness unless the measurement is below the minimum or above the maximum requirements. If the measurement is below or above the applicable requirements, three additional measurements shall be taken, one at approximate mid-width on the opposite end and one at approximate mid-length on each side of the panel, and the average of the four measurements shall be taken as the thickness of that panel.

**3.13.1 SQUARENESS** – Panels larger than 1219 mm by 1219 mm (4 feet by 4 feet) shall be square within 2.4 mm (3/32 inch). Panels 1219 mm by 1219 mm (4 feet by 4 feet) or less shall be square within 1.6 mm (1/16 inch). Squareness shall be determined by measuring the length of the diagonals of the panel.

**3.13.2 STRAIGHTNESS** – The edges of panels 2438 mm (8 ft) long or less shall be such that a straight line from one corner to the adjacent corner shall fall within 1.6 mm (1/16 inch) of the panel edge. A departure of 2.4 mm (3/32 inch) is allowed for panels longer than 2438 mm (8 ft).

**3.14 SANDING** – Plywood panels shall not be considered ready for finishing unless agreed to between buyer and seller. The types of sanding shall be as described below. The type of sanding and the number of surfaces of the panels to be sanded shall be as agreed upon between buyer and seller. Plywood panels shall not be considered ready for finishing when moisture has caused the grain to raise or when the panels have marks made during shipment or storage that require additional sanding. Panels shall have regular sanding unless otherwise specified.

No sanding – Faces need not be sanded nor tape removed.

Rough (Touch) sanding – Sanding hit-or-miss. Tape removal is not required.

Regular sanding – Surfaces shall be clean and free of tape. Sander streaks are not considered defects.

Polish sanding – Surfaces shall be clean and smoothly sanded.

**3.15 MOISTURE CONTENT** – The moisture content of plywood panels at the time of shipment from the producing mill shall not exceed 12 percent of the oven-dry weight, as determined in accordance with section 4.7.

### 3.16 FINISHED PANELS

**3.16.1 GENERAL** – The grades of finished industrial panels produced under this Standard are the same as those for unfinished panels. Panels are graded after final sanding, prior to finishing. Various finishing methods affect the appearance of wood characteristics differently. Specific appearance requirements of finished panels shall be as agreed upon between buyer and seller.

**3.16.2 FINISH PERFORMANCE** – Factory finished industrial panels shall meet the following finish performance requirements:

ANSI/KCMA A161.1 – 2022, Section 9.2, 9.3, and 9.4 Finish Tests:

Tests for compliance of finished plywood with this provision shall be conducted with samples prepared as necessary to seal or otherwise prevent exposure of the panel edges to the test conditions.

### 3.17 PRODUCT MARKING AND DESIGNATION

**3.17.1 GENERAL** – All hardwood and decorative plywood represented as conforming to this Standard shall be identified as follows:

(a) Each industrial panel 12.7 mm or 1/2 inch or thicker shall be marked with “ANSI/HPVA HP-1-2024,” the name or recognized identification of the producer, the species and grade of the face and back (if different species). Face and back grade identification is not required on panels designated only as SHOP. Such panels shall be identified as SHOP. Panel identification shall include both the HP-1 grade followed by SHOP when both designations are applicable. Panels identified as MILL RUN must include the HP-1 grade designation followed by MILL RUN. (See Section 5 for definitions of SHOP and MILL RUN.) The designation of the species of grade 4 backs is not required.

(b) Each unit or pallet of industrial panels less than 12.7 mm or 1/2 inch thick shall be marked with “ANSI/HPVA HP-1-2024,” the name or recognized identification of the producer, and the species and grade of the face and back (if different species). The designation of species of grade 4 backs is not required.

(c) In addition to panel and unit labeling, a written statement containing the information in (a) and (b) above shall accompany the shipment.

(d) Wall panels shall be marked as described in 3.17.1(a) above except that the species of the back does not have to be designated.

**3.17.1.1 TOLERANCES** – The maximum allowable tolerance of non-conformance to this Standard for the shipment or order shall be 5 percent (see Appendix A1 for more detailed description of industry practice).

**3.17.2 IDENTIFICATION OF COMPLIANCE** – For products produced, tested, and evaluated in accordance with the requirements of this Standard, manufacturers may include a statement of compliance in conjunction with their name and address on product labels, invoices, sales literature and the like (see example below). Self-compliance statements must be supported by manufacturers’ records of satisfactory product testing and evaluations.

**Sample Compliance Statement:** *This hardwood plywood was produced and evaluated in accordance with the requirements established in American National Standard ANSI/HPVA HP-1-2024. Full responsibility for the conformance of this product to the Standard is assumed by: (name and address of manufacturer).*

**3.17.3 IDENTIFICATION OF THIRD-PARTY CERTIFICATION** – For purchasers to identify products third-party certified to meet all requirements of this Standard, manufacturers participating in a third-party certification program may include a statement of certification in conjunction with their name and address on product labels, invoices, sales literature and the like. All claims shall be supported by identification of an ISO/IEC 17065-accredited product certification agency.

**Sample Certification Statement:** *This hardwood plywood is certified by an ISO/IEC 17065-accredited certification agency to meet all of the requirements established in American National Standard ANSI/HPVA HP-1-2024.*

**3.17.3.1 CERTIFIED MARK** – The logo shown below is also available for use in demonstrating third-party certification to the Standard. Approval for use of the logo shall be granted by HPVA®, as the Standard developer (DBA DHA), upon successful demonstration of certification by an ISO/IEC 17065-accredited product certification agency.



**ANSI/HPVA HP-1-2024 CERTIFIED**

## 4. INSPECTION AND TEST PROCEDURES

**4.1 GENERAL** – The inspection and test procedures contained in this section are to be used to determine the conformance of products to the requirements of this Standard. Each producer or distributor who represents their products as conforming to this Standard shall keep such records as are necessary to substantiate his claim that all of the requirements of this Standard have been met. One method of establishing documentation is the use of statistically based sampling plans that are appropriate for each particular manufacturing process. Additional sampling and testing of the product, as agreed upon between purchaser and seller is not precluded by this section.

### 4.2 SPECIMENS FOR BOND LINE TESTS

**4.2.1 TECHNICAL AND TYPE I PLYWOOD** – Three test pieces shall be cut from each selected panel: one piece from each end of the panel and one piece near the center of the panel. Each test piece shall be of sufficient size to provide:

- (a) for plywood produced with at least two adjacent plies of crossing grain bond lines, at least six specimens for the dry shear test and six specimens for the cyclic-boil shear test (see section 4.4 and Table 11),
- (b) for plywood produced with at least two adjacent plies with parallel grain; four specimens for the two-cycle boil test (see section 4.5 and Table 11).

**4.2.2 TYPE II PLYWOOD** – One test piece shall be cut from each panel selected. A minimum of six test specimens for the three-cycle soak test (see section 4.6 and Table 11) shall be cut from each test piece. Test specimens shall not have common edges.

**TABLE 11 – TEST SPECIMEN SIZES**

Type of Plywood	Specimen Size	
	mm	(inches)
Technical and Type I	82.6 <sup>a</sup> by 25.4	(3 1/4 <sup>a</sup> by 1)
Technical and Type I containing parallel laminated veneers	76 by 76	(3 by 3)
Type II (3-Cycle)	127 <sup>b</sup> by 50.8	(5 <sup>b</sup> by 2)

<sup>a</sup> Specimens for testing inner plies shall be parallel to the grain of the outside veneers in 3-, 7-, and 11-ply construction and perpendicular to the grain of the outside veneers in 5- and 9-ply construction. Specimens for testing the outer plies shall always be parallel to the grain of the face veneer in the 82.6 mm (3 1/4 inches) dimension.

<sup>b</sup> Parallel to the grain of the face veneers.

**4.3 DRY SHEAR TEST** – Shear tests shall be conducted on specimens prepared as shown in Figure 3. In samples containing 3 or more plies, at least half of the specimens tested shall contain the innermost bond lines. The ends of each specimen shall be gripped in test machine retaining jaws, and the load shall be applied at the rate of 2669 to 4448 Newtons (600 to 1,000 pounds) per minute. Specimen notching shall be accomplished in such a way as to assure that when the specimens are subjected to loading, the lathe checks in the center ply of half of the specimens will be in tension, while in the other half the lathe checks will be in compression. An explanation of one method of notching specimens to ensure that half of the specimens are pulled with the lathe checks in tension and half are pulled in compression is described in ASTM D906-20<sup>8</sup>, Standard Method of Test for Strength Properties of Adhesives in Plywood Type Construction in Shear by Tension Loading. If the number of plies exceed three, the outer pairs of bond lines and inner-most bond lines shall be tested with separate sets of test specimens. In plywood with face plies thicker than 1.6 mm (1/16 inch), the shear area shall be 645 square mm (1 square inch), as shown in Figure 3, specimen A. Specimens of plywood with face plies 1.6 mm (1/16 inch) or less in thickness shall be of the form shown in Figure 3, specimen B, in which the shear area shall be reduced to 323 square mm (1/2 square inch) without changing the width of the specimen. Test machine loads obtained from specimens of 323 square mm (1/2 square inch) shear area shall be multiplied by 2 to convert to kilo Pascals (pounds per square inch) and then reduced by 10 percent before comparing with the required values set forth in Table 10. For shear tests of lumber core plywood, the core shall be cut away to 2.5 mm (1/10 inch) in thickness.

**4.4 CYCLIC-BOIL SHEAR TEST** – The specimens prepared as shown in Figure 3 shall be boiled in water for 4 hours and then dried for 20 hours at a temperature of  $63 \pm 3^{\circ}\text{C}$  ( $145 \pm 5^{\circ}\text{F}$ ) with sufficient air circulation to lower the moisture content of the specimens to a maximum of 12 percent of the

ovendry weight. They shall be boiled again for 4 hours, cooled in water, and then subjected while wet to the test described in 4.3. The values obtained from the six specimens shall meet the applicable requirements given in Table 10. If the number of plies exceeds three, the outer pairs of bond lines and innermost bond lines shall be tested with separate sets of test pieces. In samples containing 3 or more plies, at least half of the specimens tested shall contain the innermost bond lines.

**4.5 TWO-CYCLE BOIL TEST** – The 76 mm by 76 mm (3 inches by 3 inches) specimens shall be submerged in boiling water for 4 hours  $\pm$  10 minutes and then dried at a temperature of  $63 \pm 3^{\circ}\text{C}$  ( $145 \pm 5^{\circ}\text{F}$ ) for 20 hours  $\pm$  30 minutes with sufficient air circulation to lower the moisture content of the specimens to a maximum of 12 percent of the ovendry weight. They shall be boiled again for 4 hours  $\pm$  10 minutes, dried for three hours  $\pm$  10 minutes at a temperature of  $63 \pm 3^{\circ}\text{C}$  ( $145 \pm 5^{\circ}\text{F}$ ), and then examined for delamination. Any observed delamination greater than 25.4 mm (1 inch) in continuous length constitutes failure of the specimen. Within any given lot of test samples, 90% of the individual specimens must pass. This method shall only be used for parallel grain testing as specified in 4.2.1(b).

**4.6 THREE-CYCLE SOAK TEST** – The 127 mm by 50.8 mm (5 inches by 2 inches) specimens from each test panel shall be submerged in water at  $24 \pm 3^{\circ}\text{C}$  ( $75 \pm 5^{\circ}\text{F}$ ) for 4 hours  $\pm$  10 minutes and then dried at a temperature between 49 and  $52^{\circ}\text{C}$  (120 and  $125^{\circ}\text{F}$ ) for 19 hours  $\pm$  30 minutes with sufficient air circulation to lower the moisture content of specimens to 12 percent or below of the ovendry weight. This cycle shall be repeated until all specimens fail or until three cycles have been completed, whichever occurs first. A specimen shall be considered as failing when any single delamination between two plies is greater than 50.8 mm (2 inches) in continuous length, over 6.4 mm (1/4 inch) in depth at any point, and 0.08 mm (0.003 inch) in width, as determined by a feeler gauge 0.08 mm (0.003 inch) thick and 12.7 mm (1/2 inch) wide. Delamination due to tape at joints of inner plies or defects

<sup>8</sup> The latest issue of ASTM publications shall be used provided the requirements are applicable and consistent with the issues designated. ASTM publications may be purchased from ASTM International, 100 Barr

Harbor Drive, PO Box C700, West Conshohocken, PA 19428-2959 USA, [www.astm.org](http://www.astm.org).



allowed by the grade shall be disregarded. Five of the 6 specimens shall pass the first cycle and 4 of the 6 specimens shall pass the third cycle in 90% of the panels tested. Within any given selection of test panels, 95% of the individual specimens shall pass the first cycle and 85% of the specimens shall pass the third cycle.

**4.7 MOISTURE CONTENT TEST** – The moisture content of plywood shall be determined as follows: a small test specimen shall be cut from the sample panel; the test specimen shall measure not less than 5806 square mm (9 square inches) in area and shall weigh not less than 20 grams. All loose splinters shall be removed from the specimen. The specimen shall be immediately weighed to the nearest 0.1 of a gram, and the weight shall be recorded as the original weight. The specimen shall then be dried in an oven at 100 to 105°C (212 to 221°F) until constant weight is attained. After drying, the specimen shall be reweighed immediately, and this weight shall be recorded as the oven-dry weight. The moisture content shall be calculated as follows:

$$\frac{(\text{Original Weight} - \text{Oven-dry Weight}) \times 100}{\text{Oven-dry Weight}} = \text{Moisture Content (\%)}$$

Figure 3 – Plywood Bond Shear Specimens

Shear Area Specimen Configurations:

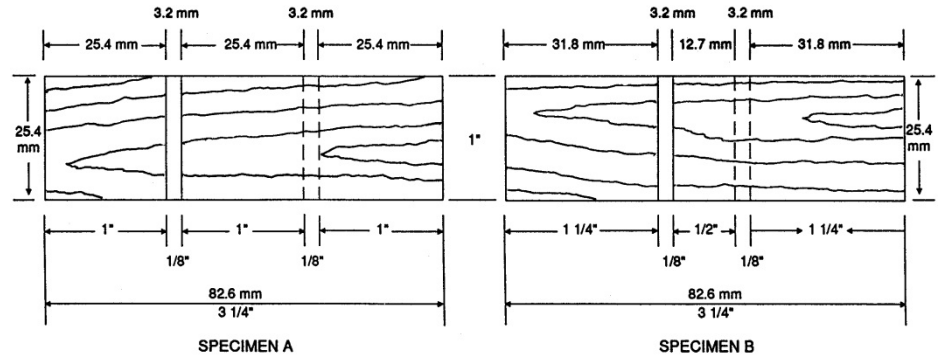

Specimen Notching (5-ply innermost bond line):

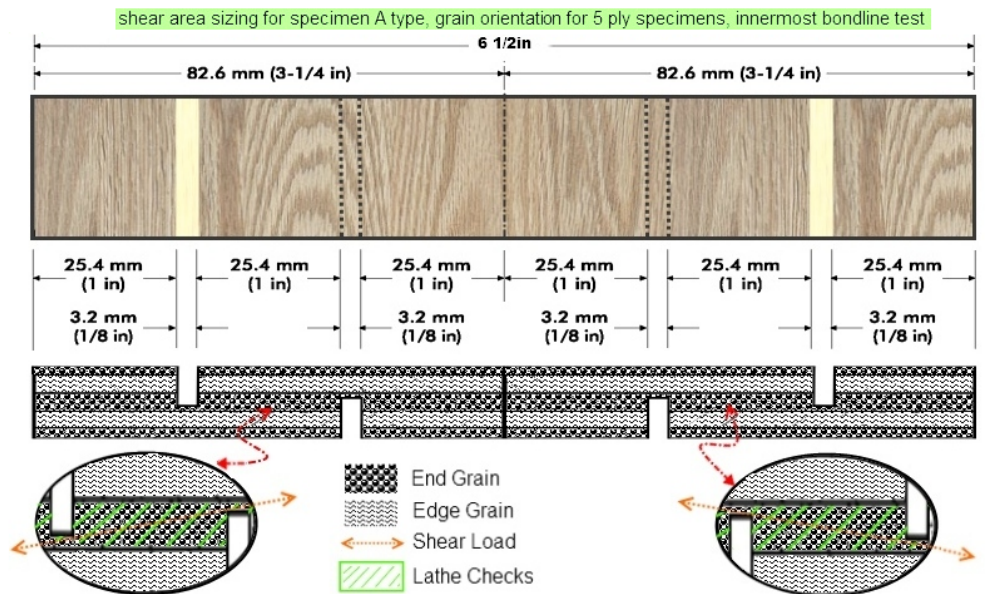

Specimen Notching (3-ply innermost bond line):\*

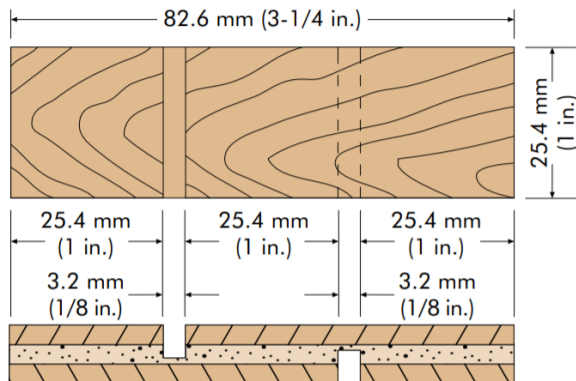

Specimen Notching (5-ply outermost bond line):\*

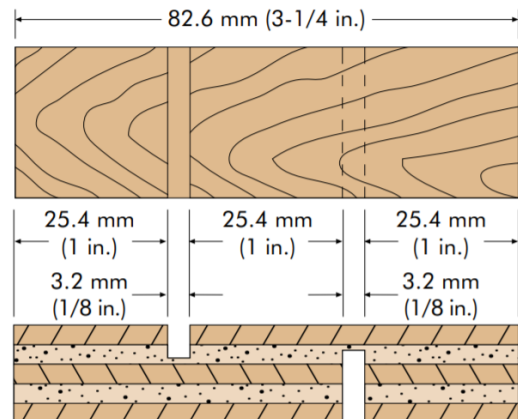

\*Source: The Engineered Wood Association (APA), Voluntary Product Standard: PS 1 Structural Plywood

## 5. DEFINITIONS

The terms used in this Standard are defined as follows:

**BACK** – The side reverse to the face of a panel or the poorer side of a panel in any grade of plywood calling for a face and back.

**BALANCED MATCH** – Two or more veneer components or leaves of equal size to make up a single face.

**BALANCED PANEL** – For purposes of this Standard, a balanced panel is one which is free from warp that affects serviceability for its intended use

**BANDING** – Portion of wood extending around one or more sides of plywood panels.

**BARK POCKET** – Bark around which normal wood has grown.

**BLENDING** – Color change that is detectable at a distance of 1.8 m to 2.4 m (6 feet to 8 feet) but which does not detract from the overall appearance of the panel.

**BOOK MATCH** – Adjacent pieces of veneer from a flitch or log are opened like a book and spliced to make up the face with matching occurring at the spliced joints (see Figure 1 for illustration). The fibers of the wood, slanting in opposite directions in the adjacent sheets, create a characteristic light and dark effect when the surface is seen from an angle.

**BRASHNESS** – Condition of wood characterized by low resistance to shock and by abrupt failure across the grain without splintering.

**BURL, CONSPICUOUS** – A swirl, twist, or distortion in the grain of the wood which usually occurs near a knot or crotch. A conspicuous burl is associated with abrupt color variation and/or a cluster of small dark piths caused by a cluster of adventitious buds.

**BURL, BLENDING** – A swirl, twist, or distortion in the grain of the wood which usually occurs near a knot or crotch but does not contain a knot and does not contain abrupt color variation. A blending burl is detectable at 1.8 m to 2.4 m (6 feet to 8 feet) as a swirl or roundel.

**CATHEDRAL** – A grain appearance characterized by a series of stacked and inverted “V”, or cathedral type of springwood (earlywood) summerwood (latewood) patterns common in plain-sliced (flat-cut) veneer (See **SPLIT HEART**).

**CENTERS** – Inner plies whose grain direction runs parallel to that of the outer plies. Included as centers are parallel laminated plies.

**CENTER MATCH** – An even number of veneer components or leaves of equal size matched with a joint in the center of the panel to achieve horizontal symmetry.

**CHECKS** – Small slits running parallel to grain of wood, caused chiefly by strains produced in seasoning.

**COMBINATION CORE** – A core which includes two or more different types of wood-based material, one of which is a

reconstituted wood product (See **RECONSTITUTED WOOD**).

**COMB GRAIN** – A quality of rift cut veneer with exceptionally straight grain and closely spaced growth increments resembling the appearance of long strands of combed hair.

**COMPONENT (OF FACE)** – An individual piece of veneer that is jointed to other pieces to achieve a full length and width face. Terms used interchangeably with *component* in the context of the face are *piece* and *leaf*.

**COMPRESSION FAILURE** – See **CROSS BREAK**

**CONSPICUOUS** – See **BURL, CONSPICUOUS AND KNOTS, CONSPICUOUS PIN**.

**COLOR VARIATION** – The range of coloring across the entire surface of a face veneer. **COLOR VARIATION** is not to be confused with “sharp color contrasts at joints,” a separate face grade criteria that applies only to the observation of sharp color contrast at joints between components in a full length and width face veneer.

**CORE** – The inner part of plywood between face and back, usually veneer. Sawn lumber, particleboard, MDF, hardboard, OSB or other material are also used as cores.

**CORE, BANDED** – Core that has been made with banding on one or more sides.

**CROSSBANDING** – Veneer used in the construction of plywood with five or more plies. Crossbands are placed at right angles to the grain of the faces and are typically placed adjacent to the face and back. Also refers to all inner layers of veneer whose grain direction runs perpendicular to that of the outer plies and includes parallel laminated plies.

**CROSS BAR** – Irregularity of grain resembling a dip in the grain running at right angles, or nearly so, to the length of the veneer.

**CROSS BREAK** – Separation of the wood cells, often appearing as barely distinct fine irregular lines across the grain. Such breaks are often due to internal strains resulting from unequal longitudinal shrinkage or to external forces (See **COMPRESSION FAILURE**).

**CROWS FOOT** – Open splits within a knot, fanning out from the center/eye of the knot.

**CROSS FIGURE** – A series of naturally occurring figure effects characterized by mild or dominant patterns across the grain in some faces. For example, a washboard effect occurs in fiddleback cross figure; and cross wrinkles occur in mottle figure.

**DECAY** – The decomposition of wood substance by fungi. The incipient stage is characterized by discoloration and sometimes accompanied by a softening of the wood substance. The final or ultimate stage is characterized by the partial or complete collapse of the wood structure and the destruction of the wood substance.

- DEFECT, OPEN** – Checks, splits, open joints, knotholes, cracks, loose knots, wormholes, gaps, voids, or other openings interrupting the smooth continuity of the wood surface.
- DELAMINATION** – Separation of plies or layers of wood or other material through failure of the adhesive bond.
- DISCOLORATIONS** – Stains in wood substances. Common veneer stains are sap stains, blue stains, stain produced by chemical action caused by the iron in the cutting knife coming in contact with the tannic acid of the wood, and those resulting from exposure of natural wood extractives to oxygen and light, to chemical action of vat treatments or the adhesive components, and/or to the surface finish.
- DOZE** – (SYNONYMOUS WITH DOTE) – A form of incipient decay characterized by a dull and lifeless appearance of the wood, accompanied by a loss of strength and softening of the wood substance.
- EMISSION LEVEL** – The formaldehyde concentration in testing wood panel products using ASTM E1333, *Standard Test Method for Determining Formaldehyde Levels From Wood Products Under Defined Test Conditions Using A Large Chamber* or equivalent ASTM D6007, *Standard Test Method for Determining Formaldehyde Concentration in Air from Wood Products using a Small Chamber*.
- ENGINEERED VENEER** – Veneers that are first peeled, normally from obeche or poplar logs. The peeled veneer leaves are dyed to a specified color, and then glued together in a mold to produce a large laminated block. The shape of the mold determines the final grain configuration. The block is then sliced into leaves of veneer with a designed appearance that is highly repeatable.
- FACE** – The better side of any plywood panel in which the outer plies are of different veneer grades. Also either side of a panel in which there is no difference in the veneer grade of the outer plies.
- FEW** – A small number of characteristics without regard to their arrangement in the panel.
- FIGURE** – The pattern produced in a wood surface by annual growth rings, rays, knots, deviations from natural grain such as interlocked, curly and wavy grain, and irregular coloration.
- FINGER JOINT** – A series of fingers machined on the ends of two pieces of wood to be joined, which mesh together and are held firmly in position with an adhesive.
- FLAKE** – See **FLECK, RAY**.
- FLAT-CUT** – See **PLAIN-SLICED**.
- FLECK, RAY** – Portion of a ray as it appears on the quartered or rift-cut surface. Fleck is often a dominant appearance feature in oak.
- FLITCH** – A complete bundle of veneer sheets laid together in sequence as they are cut from a given log or section of a log.
- GAP** – Open slits in the inner plies or improperly joined veneers.
- GRAIN** – The direction, size, arrangement, and appearance of the fibers in wood or veneer.
- GRAIN SLOPE** – Expression of the angle of the grain to the long edges of the veneer component.
- GRAIN SWEEP** – Expression of the angle of the grain to the long edges of the veneer component over the area extending one-eighth of the length of the piece from the ends.
- GUM POCKETS** – Well-defined openings between rings of annual growth, containing gum or evidence of prior gum accumulations.
- GUM SPOTS AND STREAKS** – Gum or resinous material or color spots and streaks caused by prior resin accumulations sometimes found on panel surfaces.
- HAIRLINE** – A thin, perceptible line showing at the joint of two pieces of wood.
- HALF-ROUND** – A method of veneer cutting similar to rotary cutting, except that the piece being cut is secured to a “stay log,” a device that permits the cutting of the log on a wider sweep than when mounted with its center secured in the lathe to produce rotary sliced veneer. A type of half-round cutting is used to achieve plain-sliced or flat-cut veneer.
- HARDBOARD** – A panel manufactured primarily from inter-felted lignocellulosic fibers consolidated under heat and pressure in a hot press to a density of 500 kg/m<sup>3</sup> (31 lbs. /ft<sup>3</sup>) or greater by: A) a wet process; or B) a dry process that uses a phenolic resin, or a resin system in which there is no added formaldehyde as part of the resin cross-linking structure; or C) a wet formed/dry pressed process. Other materials may be added to improve certain properties, such as stiffness, hardness, finishing properties, resistance to abrasion and moisture, as well as to increase strength, durability, and utility.
- HARDWOOD** – General term used to designate lumber or veneer produced from trees which are usually deciduous or tropical broad-leaved flowering trees which bear fruit, referred to as angiosperms. Contrast with softwood (See **SOFTWOOD**). The term “hardwood” does not infer hardness in the physical sense.
- HEARTWOOD** – The non-active or dormant center of a tree, generally distinguishable from the outer portion (sapwood) by its darker color, sometime referred to as heart.
- HIGH DENSITY FIBERBOARD** – See **HARDBOARD**.
- INCONSPICUOUS** – Barely detectable with the naked eye at a distance of 1.8 m to 2.4 m (6 feet to 8 feet) (See **BLENDING**).
- INDUSTRIAL PANELS** – Generally unfinished multi-ply products which consist of various combinations of hardwood or decorative veneer faces and inner ply materials (e.g., veneer, particleboard, MDF, and hardboard). These are generally cut-to-size and stock panels used in making

- cabinets, furniture, laminated block flooring, and panels for other non-structural applications.
- INNER PLYS** – Plys other than face or back plys in a panel construction. Crossbands and centers are classed as inner plys (See **CORE**).
- JOINT** – The common edge between two adjacent materials in the same plane.
- JOINT, EDGE** – Joint running parallel to the grain of the wood.
- JOINT, OPEN** – Joint in which two adjacent pieces of veneer in the same plane do not fit tightly together.
- KNIFE MARK** – Caused by a nicked knife during process of slicing or peeling decorative veneer where a visibly apparent, linear, indented or raised strip of wood is deep or high enough to be felt with a fingernail.
- KNOT** – Cross section of tree branch or limb with grain usually running at right angles to that of the piece of wood in which it occurs.
- KNOT, OPEN** – Opening produced when a portion of the wood substance of a knot has dropped out or where cross checks have occurred to produce an opening.
- KNOTHOLES** – Openings produced when knots drop from the wood in which they were embedded.
- KNOTS, BLENDING PIN** – Sound knots 6.4 mm (1/4 inch) or less that generally do not contain dark centers. Blending pin knots are barely detectable at a distance of 1.8 m to 2.4 m (6 feet to 8 feet), do not detract from the overall appearance of the panel, and are not prohibited from appearing in all grades.
- KNOTS, CONSPICUOUS PIN** – Sound knots 6.4 mm (1/4 inch) or less in diameter containing dark centers.
- KNOTS, SOUND, TIGHT** – Knots that are solid across their face and fixed by growth to retain their place.
- KNOTS, SPIKE** – Knots cut from 0° to 45° to the long axis of limbs.
- LAP** – A condition where one piece of veneer in the same ply overlaps another piece.
- LAYER** – A single veneer ply or two or more plys laminated with grain direction parallel (See **PLY**). Two or more plys laminated with grain direction parallel is a parallel laminated layer.
- LOOSE SIDE** – In knife-cut veneer, the side of the sheet that was in contact with the knife as the veneer was being cut, and has cutting checks (lathe checks) because of the bending of the wood at the knife edge.
- MANUFACTURER** – A producer of hardwood and/or decorative plywood.
- MEDIUM DENSITY FIBERBOARD (MDF)** – A composite panel product composed primarily of cellulosic fibers and a bonding system cured under heat and pressure. MDF density is typically between 500 kg/m<sup>3</sup> (31 lbs./ft<sup>3</sup>) and 1000 kg/m<sup>3</sup> (62 lbs./ft<sup>3</sup>). For formaldehyde emission limits, thin MDF is defined as MDF with a thickness less than or equal to 8 mm (0.315 inches).
- MILL RUN** – A defined lot of panels which may include SHOP panels up to the amount agreed to between buyer and seller. Alternately referred to as BLENDED SHOP (see **SHOP**).
- MINERAL** – See **STREAKS, MINERAL**.
- NATURAL** – When referring to color and matching, veneers containing any amount of sapwood and/or heartwood.
- NO ADDED FORMALDEHYDE (NAF)** – A resin formulated with no added formaldehyde as part of the resin crosslinking structure in a composite wood product that meets the emission standards in Section 770.17(c) of the EPA TSCA Title VI regulation and Section 93120.3(d) of the CARB regulation.
- NOMINAL** – A term that designates a stated dimension as being approximate and subject to allowances for variation.
- OCCASIONAL** – A small number of characteristics that are arranged somewhat diversely within the panel face.
- PARTICLEBOARD** – A generic term for a composite panel primarily composed of cellulosic materials (usually wood), generally in the form of discrete pieces or particles, as distinguished from fibers, bonded together with a bonding system, and which may contain additives.
- PECKY** – Pockets of disintegrated wood caused by localized decay or wood areas with abrupt color change related to localized injury such as bird peck. Peck is sometimes considered as a decorative effect, such as bird peck in pecan and hickory or pecky in cypress.
- PLAIN-SLICED (FLAT-CUT)** – Veneer sliced parallel to the pith of the log and approximately tangent to the growth rings to achieve flat-cut veneer. Plain-sliced veneer is cut using either a horizontal or vertical slicing machine or by the half-round method on a lathe.
- PLANK MATCHED** – A panel having the face made up of specially selected and assembled dissimilar (in color, or grain, or width) veneer strips of the same species, and sometimes grooved at the joints between strips to simulate lumber planking.
- PLEASING MATCHED** – A face containing components which provides a pleasing overall appearance. The grain of the various components need not be matched at the joints. Sharp color contrasts at the joints of the components are not permitted.
- PLY** – A single sheet of veneer or several strips laid with adjoining edges that may or may not be glued, which forms one veneer lamina in a glued panel (see **LAYER**). In some constructions, a ply is used to refer to other wood components such as particleboard or MDF.
- PLYWOOD, HARDWOOD or DECORATIVE** – A bonded assembly intended for interior use with at least one

decorative veneer surface with a core consisting of an assembly of layers or plies of veneer, or veneers in combination with lumber, particleboard, MDF, hardboard, or special core in which the adjacent layers or plies are at approximately right angles.

**QUARTER-SLICED (QUARTER-CUT)** – A straight grain appearance achieved through the process of quarter-slicing or through the use of veneer cut in any fashion that produces a straight grain effect. Cut is radial to the pith to the extent that ray fleck is produced, and the amount of fleck is not limited.

**RANDOM MATCHED (MISMATCHED)** – A panel having a face made up of veneer strips of the same species which are selected and assembled without regard to color or grain, resulting in variations, contrasts and patterns of color and grain. Pleasing appearance is not required.

**RAY FLECK** – See **FLECK**.

**RECONSTITUTED WOOD** – A generic term for panel products made with strands, wafers, particles, or fibers of wood. Individual products include hardboard, insulation board, particleboard, MDF, and oriented strand board (OSB) or waferboard. Particleboard and MDF normally use urea-formaldehyde resin as the binding agent. OSB/waferboard normally use phenol-formaldehyde as the binding agent. Most hardboard and insulation board use the lignin from the processed wood as the binding agent. Most dry-process hardboards contain phenol-formaldehyde to increase bonding strength.

**RECONSTITUTED BLOCK** – A generic term for cellulosic biomaterials re-assembled into a resource for veneer production.

**RED/BROWN** – When referring to color and matching, veneers containing all heartwood, ranging in color from light to dark.

**REPAIRS** – A patch, shim, or filler material inserted and/or glued into veneer or a panel to achieve a sound surface.

**REPAIRS, BLENDING** – Wood or filler insertions similar in color to adjacent wood so as to blend well.

**RIFT-CUT** – A straight grain appearance achieved through the process of cutting at a slight angle to the radial on the half-round stay log or through the use of veneer cut in any fashion that produces a straight grain with minimal ray fleck.

**ROTARY-CUT** – Veneer produced by centering the log in a lathe and turning it against a broad cutting knife which is set into the log at a slight angle.

**ROUGH CUT** – Irregular shaped areas of generally uneven corrugation on the surface of veneer, differing from the surrounding smooth veneer and occurring as the veneer is cut by the lathe or slicer.

**RUNNING MATCH** – The panel face is made from components running through the flitch consecutively. Any portion of a component left over from a face is used as the beginning component or leaf in starting the next panel.

**RUPTURED GRAIN** – A break or breaks in the grain or between springwood and summerwood caused or aggravated by excessive pressure on the wood by seasoning, manufacturing or natural processes. Ruptured grain appears as a single or series of distinct separations in the wood such as when springwood is crushed, leaving the summerwood to separate in one or more growth increments.

**SAPWOOD** – The living wood of lighter color occurring in the outer portion of a tree, sometimes referred to as sap.

**SHAKE** – A separation or rupture along the grain of wood in which the greater part occurs between the rings of annual growth (see **RUPTURED GRAIN**).

**SHARP CONTRASTS** – For purposes of this Standard, this term means that face veneer of lighter than average color shall not be joined at the edges with veneer of darker than average color and that two adjacent pieces of veneer shall not be widely dissimilar in grain, figure, and other natural character markings.

**SHOP** – A common industry term defined as a panel which has marks, characteristics and manufacturing defects not described in applicable requirements for a designated HP-1 outer ply grade, or a panel which is not designated as any specific HP-1 outer ply grade. Specific characteristics as agreed to between buyer and seller.

**SLICED** – Veneer produced by thrusting a log or sawed flitch into a slicing machine which shears off the veneer in sheets.

**SLIGHT** – Visible on observation, but does not interfere with the overall aesthetic appearance with consideration of the applicable grade and common species characteristics of the panel.

**SLIP MATCHED** – A sheet from a flitch is slid across the sheet beneath and, without turning, spliced at the joints (see Figure 1 for illustration).

**SMOOTH, TIGHT CUT** – Veneer cut to minimize lathe checks.

**SOFTWOOD** – General term used to designate lumber or veneer produced from trees which are usually non-deciduous and needle-bearing with naked seeds (cones), referred to as gymnosperms. Contrast with hardwood (See **HARDWOOD**). The term “softwood” does not infer softness in the physical sense.

**SOLID CORE** – Plywood panels in which all inner plies are grade J or better. Splits up to 3.2 mm (1/8 inch) are allowed.

**SPECIES (COMMERCIAL SPECIES GROUPS)** – Species generally grouped for marketing convenience and identified with a single commercial name (See ASTM D 1165, Standard Nomenclature of Domestic Hardwoods and Softwoods, for commercial practice in the United States and Canada).

**SPECIES (TREES)** – An internationally established Latin botanical classification of trees.

**SPECIFIC GRAVITY** – The ratio of the weight of a certain volume of a substance to the weight of an equal volume of water, the temperature of which is 4°C (39.2°F).

**SPLIT HEART** – A method of achieving an inverted “V” or cathedral type of springwood (earlywood)/summerwood (latewood), plain-sliced (flat-cut) figure by joining two face components of similar color and grain. A cathedral type figure must be achieved by a single component in “AA” grade; the split heart method is allowed in grades “A” through “E.” Each half of a split heart shall be subject to the minimum component width requirements for grade “A” and “B” faces.

**SPLITS** – Separations of wood fiber running parallel to the grain.

**STREAKS, MINERAL** – Sharply contrasting elongated discolorations of the wood substance.

**SUGAR** – See **WORM TRACKS**.

**ULTRA LOW EMITTING FORMALDEHYDE (ULEF)** – A resin in a composite wood product that meets the emission standards in Section 770.18(c) of the EPA TSCA Title VI regulation and Section 93120.3(c) of the CARB regulation.

**TAPE** – Strips of gummed paper or cloth sometimes placed across the grain of large veneer sheets to facilitate handling and sometimes used to hold the edges of veneer together at the joint prior to gluing.

**TIGHT SIDE** – In knife-cut veneer, that side of the sheet that was farthest from the knife as the sheet was being cut and contains no cutting checks (lathe checks).

**VENEER, CORE** – A layer of softwood, hardwood, or woody grass which is rotary cut, sliced, or sawed from a log, cant, or block, used below the face or back in the construction of hardwood plywood.

**VENEER, DECORATIVE** – A layer of softwood, hardwood, reconstituted block, or woody grass which is rotary cut, sliced, or sawed from a log, cant, or block, used as the face or back in hardwood plywood.

**VINE MARK** – Bands of irregular grain running across or diagonally to the grain which are caused by the growth of climbing vines around the tree.

**WALL PANELS** – Generally up to 5-ply grooved or ungrooved plywood or reconstituted wood panels, generally in thicknesses of 12.7mm (1/2 inch) or less, with at least one surface decorated and protected with a liquid applied or film overlay finish.

**WHITE** – When referring to color and matching, veneers containing all sapwood, ranging in color from pink to yellow.

**WOOD FAILURE (PERCENTAGE)** – The area of wood fiber adhering at the glue line following completion of the specified shear test. Determination is by visual examination. The value is expressed as an estimated percentage of the

wood area remaining adhered to the fractured surface in the test area.

**WOOD FILLER** – An aggregate of resin and strands, shreds, or flour of wood which is used to fill openings in wood and provide a smooth, durable surface.

**WOODY GRASS** – A fast growing member of the grass family utilized with commercial applications as a wood substitute due to its rapidly renewable properties.

**WORMHOLES** – Holes resulting from infestation of worms.

**WORM TRACKS** – Marks caused by various types of wood attacking larvae. Often appear as sound discolorations running with or across the grain in straight to wavy streaks. Sometimes referred to as “pith flecks” in certain species of maple, birch and other hardwoods because of a resemblance to the color of pith.

## 6. IDENTIFICATION

In order that purchasers are able to identify products conforming to all requirements of this Standard, producers and distributors shall be permitted to include a statement of compliance in conjunction with their name and address on invoices, sales literature, and the like. When space is available the following statement shall appear:

*This plywood conforms to all of the requirements established in ANSI/HPVA HP-1-2024 developed cooperatively with the industry and published by the Hardwood Plywood and Veneer Association® DBA the Decorative Hardwoods Association. Full responsibility for the conformance of this product to the Standard is assumed by (name and address of producer or distributor).*

When space is not available for the full statement, the following abbreviated statement shall appear:

*Conforms to ANSI/HPVA HP-1-2024 (name and address of producer or distributor).*

These Appendices are not a part of ANSI/HPVA HP-1-2024 but are included for information purposes only.

## APPENDIX A

### RE-INSPECTION PRACTICES, METHOD OF ORDERING, PRODUCT MARKING FORMAT

**A.1. RE-INSPECTION PRACTICES** – The following, based on general industry practices, is offered only for the information of purchasers of hardwood and decorative plywood. This information does not affect the requirements of this Standard or take precedence over purchasing agreements.

Because the provisions of this Standard apply to each and every panel represented as conforming to the Standard, and because some tests for determining conformance destroy the panel, provisions for sampling during re-inspection to determine conformance of shipments with purchase agreements should be included in the original purchase agreement.

All complaints regarding the quality of any shipment should be made within 15 days from receipt thereof. The buyer should report any defects to the seller after receipt of the panels at the stage of further processing at which detection of the defects is first possible. The seller should not be responsible for any of the cost of processing done by buyer on defective panels. The responsibility of the seller should be limited to the replacement of, or the cost of, defective material as specified in the original purchase agreement.

If the grade, bond line integrity, or other attribute of this Standard of any shipment is in dispute, the buyer and seller may select a qualified agency to re-inspect the shipment or an agreed upon sample from the shipment. A qualified agency is defined as one that has the facilities and trained technical personnel to perform the re-inspection, has developed procedures to be followed in performing the re-inspection, is not financially dependent upon any single company manufacturing the product, and is not owned, operated, or controlled by any such company. The cost of such a re-inspection should be borne by the seller if the shipment exceeds a 5% tolerance. The buyer need not accept those panels established as a result of the re-inspection as being below grade, failing to exhibit good bond line integrity, and not complying with other attributes of this Standard, but should accept the balance of the shipment as invoiced.

If the re-inspection establishes that the shipment is within the 5% tolerance, the buyer should pay for the shipment as invoiced as well as the cost of the re-inspection.

**A.2. METHOD OF ORDERING** – The recommended procedure for ordering decorative plywood is to list the following:

1	Quantity
2	Construction Type: (face, back, core specifications, bond line durability)
3	Face and back species, grade, aesthetics, color, etc.
4	Dimensions: thickness, width, length
6	Grade of face and back ply, pattern or type of cut, and matching requirements
7	Species of back ply and, if applicable, whether light, medium, or dark color
8	Species and grade of lumber core and type of banding (if required)
9	Type and grade of composite core (if required) (i.e., MDF, Hardboard, Particleboard, Combination Core, Special Core)
10	Sanding requirements
11	Certification Requirements (HP-1, CARB/TSCA Title VI, CANFER, LTDD, FSC, SFI, etc.)
12	Inner-ply grade (beneath Specialty and Rustic Grade only)

**A.3. PRODUCT MARKING FORMAT** – The following is the recommended format for marking decorative plywood panels.

**ANSI/HPVA HP-1 Markings:** Markings for product specification items covered by ANSI/HPVA HP-1, such as the following, are grouped together. For certain items listed below, product marking is a mandatory requirement under HP-1. Other items are optional, or may not be applicable. Refer to HP-1 section 3.17 regarding mandatory marking requirements pertaining to the manufacturer, species, grade, formaldehyde emissions, and dimensions.

- (1) Panel Thickness Class designation (do not include reference to any unit of measure)
- (2) Nominal length and width
- (3) Face grade



- (4) Back grade
- (5) Face pattern or type of cut, e.g., RC (rotary cut), PS (plain sliced), Q (quartered), WP (whole piece)
- (6) Face species, and color if applicable under HP-1, e.g., Sap or Heart. Proprietary color designation markings should not be included here.
- (7) Back pattern or type of cut
- (8) Back species
- (9) Core type or total plies in veneer core, e.g., LC (lumber core), PB (particleboard core), 2+5 PLY (two-step veneer core panel with 5-ply platform)
- (10) Bond line type, e.g., TYPE II
- (11) ANSI/HPVA HP-1-2024
- (12) Producer’s name or recognized identification
- (13) Production date or lot number
- (14) Product category, e.g., WP (wall panel), IP (industrial panel)
- (15) Other markings – Panel markings for proprietary specifications or other information not related to the HP-1 Standard are located separate from HP-1 related markings. Proprietary product names and color designations should be included here.

Panel Marking Examples:

Example 1:

(1)	(2)	(3)	(4)	(5)	(6)	(9)	(10)	(11)	(12)	(13)	(14)
¾ Class	48 X 96	A	2	RC	OAK	7 PLY	TYPE II	ANSI/HPVA HP-1-2024	HWPW INC.	01-01-00	IP

Example 2:

(1)	(2)	(3)	(4)	(5)	(6)	(11)	(12)	(13)	(14)	(15)
.500 Class	48 X 48	A	2	RC	OAK	ANSI/HPVA HP-1-2024	HWPW, INC	01-01-00	IP	HONEY OAK

Example 3:

(1)	(2)	(3)	(4)	(5)	(6)	(11)	(12)	(13)	(14)
12.7 Class	48 X 96	A	2	RC	OAK	ANSI/HPVA HP-1-2024	HWPW, INC.	01-01-00	IP

Example 4:

(1)	(2)	(3)	(4)	(5)	(6)	(11)	(12)	(13)	(14)	(15)
0.375 Class	48 X 96	A	2	RC	OAK	ANSI/HPVA HP-1-2024	HWPW, INC.	01-01-00	IP	ANTIQUE WHITE

Example 5:

(1)	(2)	(3)	(4)	(5)	(6)	(11)	(12)	(13)	(14)	(15)
½ Class	48 X 96	R	2	RC	OAK	ANSI/HPVA HP-1-2024	HWPW, INC.	01-01-00	IP	CO. DESIGNATION

## APPENDIX B

## EUROPEAN STANDARDS FOR HARDWOOD PLYWOOD

## SAMPLE PERFORMANCE CHARACTERISTIC EVALUATIONS FOR CE MARKING

The summary table below is provided for information purposes only and may be subject to revisions and interpretations. Contact the competent authorities for the most recent requirements.

Performance characteristics of hardwood-plywood panels to be shown for CE marking <sup>a</sup>		European standards to evaluate such performances on panels according to types			CE marking requirement	Entity that shall show "Initial trial form" to EEC as marking procedure
		Veneer core	Particleboard	MDF		
1	Bending resistance	EN 789	EN 310	EN 310	Required for CE marking as "initial trial properties verifications"	Hardwood/plywood manufacturer/laminator from information obtained from its core manufacturer
2	Bond quality (plies gluing)	CEN/TS 13354 EN 314-1,2	N/A	N/A		
3	Internal cohesion/traction resistance	N/A	EN 319	EN 319		
4	Thickness swelling	N/A	EN 317	EN 317		
5	Moisture resistance (durability)	CEN/TS 13354 EN 314-1,2	EN 321 determined under EN 310	EN 321, EN 319 EN 317		
6	Formaldehyde emission E1 and E2	EN 717-1				Hardwood/plywood manufacturer/laminator and core manufacturer
7	Fire resistance	EN 636 and EN 13501-1	EN 312 and EN 13501-1	EN 622-5 and EN 13501-1	Not required for CE marking but required by EEC Building Code	If required by the building code, both hardwood plywood manufacturer/laminator and core manufacturer
8	Permeability to water vapor	EN ISO 12572 or Section 5.9 of EN 13986:2004+A1:2015			Not required for CE marking but subject to customer's requirement	If decorative species is recognized to modify initial properties, this is the responsibility of hardwood/plywood manufacturer/laminator
9	Airborne sound insulation	EN 13986:2004+A1:2015 Section 5.10				
10	Acoustic absorption	EN ISO 354 or Section 5.11 of EN 13986:2004+A1:2015				
11	Thermal conductivity	EN 12664 or Section 5.12 of EN 13986:2004+A1:2015				
12	Biological durability	CEN/TS 1099	EN 335	EN 335		
13	Pentachlorophenol (PCP) content	Follow Section 5.18 of EN 13986:2004+A1:2015				

<sup>a</sup> Since characteristic No. 2 is a requirement from the plywood platform manufacturer, for CE marking, production control requires a delamination test be conducted under EN 311 method and under EN 13986:2004 sections 6 and 6.2. For characteristic No. 6, CARB and TSCA Title VI protocol should comply with EEC standards. ISO 9001 is recognized by EEC as an acceptable mill operation control system.



# HP-1 CERTIFICATION

## Certify with Capital Testing<sup>SM</sup> to Differentiate Your Product!

Capital Testing<sup>SM</sup> is proud to offer an accredited third-party certification program designed to demonstrate full conformance to the ANSI/HPVA HP-1-2024 American National Standard for Hardwood and Decorative Plywood. Manufacturers who display the certification mark demonstrate their ongoing commitment to producing a high-quality product through ongoing independent testing, inspections, and certification of their quality system.

### Where is HP-1 Specified?

Conformance to all or parts of HP-1 is required by:

- International Code Council (ICC) International Building Code (IBC)
- International Code Council (ICC) International Residential Code (IRC)
- HUD 24 CFR 3280 Manufactured Home Construction and Safety Standards
- HUD Guide Specifications for Residential Cabinets - Section 12370
- Architectural Woodwork Institute (AWI) Architectural Woodwork Standards (AWS)
- ICC/ASHRAE 700 National Green Building Standard™ (NGBS)

### HP-1 Certified Plywood is Third-Party Verified

HP-1 certified manufacturers are subject to third-party inspections and testing to verify compliance with every specification in the standard. This includes:

- Annual Audits of Quality Control Systems
- Manufacturing Facility Inspections
- Review of Face/Back/Inner Ply Grading Policies & Procedures
- Third-Party Product Evaluations:
  - Evaluation of Dimensions & Tolerances
  - Formaldehyde Emissions Testing
  - Type I and II Glue Bond Testing
  - Moisture Content Testing
  - Finish Performance





# EXPERTS IN TESTING & CERTIFICATION

The experienced scientists and technicians at Capital Testing<sup>SM</sup> have been certifying and testing products and processes for conformance with national standards, federal and military specifications, and state and local building codes since 1954.

## Accredited Testing & Certifications

- Formaldehyde Emissions Testing
- Flammability, Flame Spread & Smoke Testing
- Physical Testing
- Specialized Product Testing
- Legal Timber Lacey Act Certification
- Engineered Wood Products Certification

## Capital Testing<sup>SM</sup> Accreditations

- ISO/IEC Standard 17065 Certification Agency
- ISO/IEC Standard 17020 Inspection Agency
- ISO/IEC Standard 17025 Testing Laboratory
- California EPA CARB Third-Party Certifier
- EPA TSCA Title VI Third-Party Certifier

“

As AHF’s third-party CARB/TSCA certifier and testing lab, the quality and reliability of Capital Testing not only provides value to our customers, it allows us to maintain our focus on additional product development work knowing our testing is in good hands.

”



MATT MYERS,  
MANAGER, RESEARCH & DEVELOPMENT  
AHF PRODUCTS

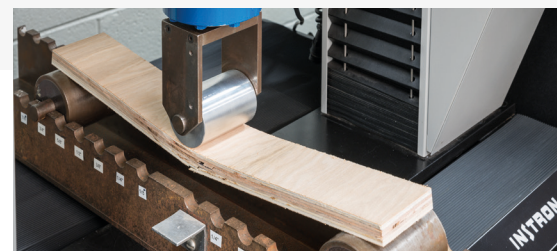

# EXHIBIT I-9



Home / Library / Reference Guides / Grading Guide / Cuts & Matching [Québec Legal Info](#) [Contact Us](#) [Blog](#) [Style Guide](#)

[ABOUT](#) [PRODUCTS](#) [RESOURCES](#) [SHOWROOM](#) [LIBRARY](#) [WHERE TO BUY](#)

# Veneer Cuts and Matching

Various methods of cutting and matching face veneers allow for a variety of exceptional options to make any project a signature work of art.



## Contact Us

1.800.637.1609

## Veneer Cuts

### Rotary Peeled

(Rotary Red Oak Whole Piece Face shown below)





An entire log is placed into a lathe and rotated in uninterrupted contact with the lathe knife, resulting in a cut that roughly parallels the growth rings to produce a bold and often variegated grain pattern. The resulting ribbon of veneer is subsequently clipped to useable widths, including sheets called whole piece or one-piece face that will cover an entire 4x8' sheet of plywood, as well as narrower leaves that will later be spliced together in order to cover a 4x8, 4x6, 8x4, or any number of sizes as may be specified by a customer. Rotary cutting is the only method of producing veneer that will produce whole piece faces.

### Sliced

(Plain Sliced Red Oak shown below)



A half or quarter log is placed on the slicer which forces it laterally against a knife to produce narrow veneer sheets with somewhat more predictable grain patterns. These sheets will later be joined together through one of the various matching methods to produce 4x8', 4x6, 8x4, or any number of sheet sizes as may be specified by a customer. Generally, slicing veneer produces more of a solid lumber appearance associated with the manner in which the half or quarter log is positioned in the slicer. Veneer leaves are kept in order as they are cut from the log to ensure a consistent appearance, making sliced veneer generally more prized than rotary cut veneer.



## Rotary Cut

Entire log is peeled producing a continuous ribbon of veneer.



## Plain Slicing

The half log is mounted with the knife parallel to the center of the “back” of the log, then forced across the knife to produce a flat sawn lumber look, often developing a repeating grain pattern called a cathedral.



## Quarter Slicing

The quarter log is mounted in the slicer so that the knife cuts across the growth rings at approximately a right angle and parallel to the rays, resulting in a highly three dimensional ray flake appearance in red and white oak.

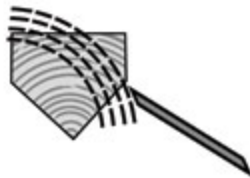

## Rift Cutting

The quarter log is mounted on a modified lathe to produce a cut that crosses both the growth rings and the rays at a slight angle, resulting in a relatively straight grain effect that minimizes the bold ray flake appearance found in quarter sliced wood.

*Note: Both quarter sliced and rift cut veneer are more often than not pulled from the straight grain portion of plain sliced veneer from the region of the log closest to its center. The resulting veneer is called quarter sliced if heavy flake is visible and rift cut when the flake is minimal. Veneers thus developed are often called false rift or quarters, but they are held to the same standard as “true” rift and quarters, reducing cost while preserving aesthetic appeal.*

## Veneer Matching



Once the veneer is cut, it can be laid up on a panel face in different sorts of “matching.” The appearance of the panel can be formal or casual, simple or busy based on the matching choice. Matching selections may be more obvious in some species than in others depending on the natural grain characteristic of that wood species.

### Book Matching

Every other leaf or component of veneer from a given log is turned over to produce a mirror image at the splice joint, much like turning the pages of a book, to produce a very aesthetically appealing look across the face.



*(Red Oak PS Book Matched shown here)*

### Slip Matching

All components from a given log are spliced together in their respective order without turning over any component, thereby producing a somewhat staggered image across the face.

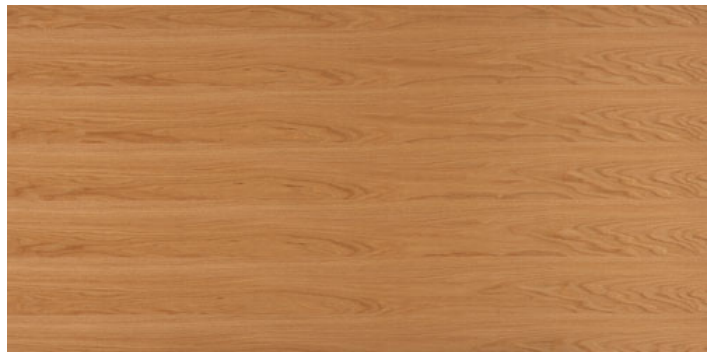

This allows for the panel face to be applied with the tight side of the veneer facing outward in order to minimize the potential for a barber pole effect occasionally observed with book matched veneer.

*(Red Oak PS Slip Matched shown here)*

### Plank Matching

Components from various logs of the same species are arranged in a deliberate mismatched manner to achieve a natural lumber effect as

offered in Columbia Forest  
Products' Appalachian  
Traditions® product line.

Barcode: 4763907-02 C-552-852 INV - Investigation -

This is often used to  
produce a rustic effect.

*(Red Oak PS Plank Matched  
shown here)*



## Random Matching

Components are arranged  
in the order they come  
from a given stack of  
veneer that may have  
come from a number of  
logs with no consideration  
given to matching for color  
or grain.



This is process often used  
to produce backs from remnant material.

*(Red Oak PS Random Matched Back shown here)*

EMAIL / PRINT / SHARE



## NEWS

[VIEW ALL](#)

6 Kitchen Cabinetry Trends to Know in  
2025

Meet the FSR: Josh Conrad

Adapting to Uncertainty: A Personal and

Filed By: [tbrightbill@wiley.law](mailto:tbrightbill@wiley.law), Filed Date: 5/22/25 12:49 AM, Submission Status: English Approved

English

Approved

# EXHIBIT I-10



# Quality Hardwood Veneer



# Quality Hardwood Veneer

*David Mercker, Extension Assistant  
George Hopper, Professor  
Forestry, Wildlife and Fisheries*

**P**riate forest landowners have long understood that some trees are distinguished as being exceptional. Not every forest contains such rare trees. In the hardwood industry, such trees are termed *veneer*. From veneer trees come veneer logs; from veneer logs come veneer sheets. Unlike most logs that are processed into conventional lumber, veneer sheets are thin layers of wood produced by slicing logs.

Essentially any log can be processed as veneer. However, for hardwood trees, normally only those logs of desired species and with the finest characteristics are selected. This is especially the case when the finished wood product is used as a **face veneer** (surface-covering) on top of core stock veneer for decorative purposes. **Core stock** is the underlayer on which the face veneer is placed. Core stock is common and does not require the fine characteristics as does face veneer. For example, red oak cabinets could have side panels with a thin layer of fine oak face veneer overlaid on a thicker layer of common yellow poplar core stock. The focus of this publication is primarily on hardwood face veneer and the trees that are used to produce it.

Veneer is erroneously accepted as a modern development in the forest product industry. In truth, veneer was used in Egyptian coffins nearly 3,500 years ago. Modernization and expansion in the veneer industry occurred in the 20<sup>th</sup> century, improving construction and design of furniture and leading to better utilization of the wood resource.

*Figure 1.*

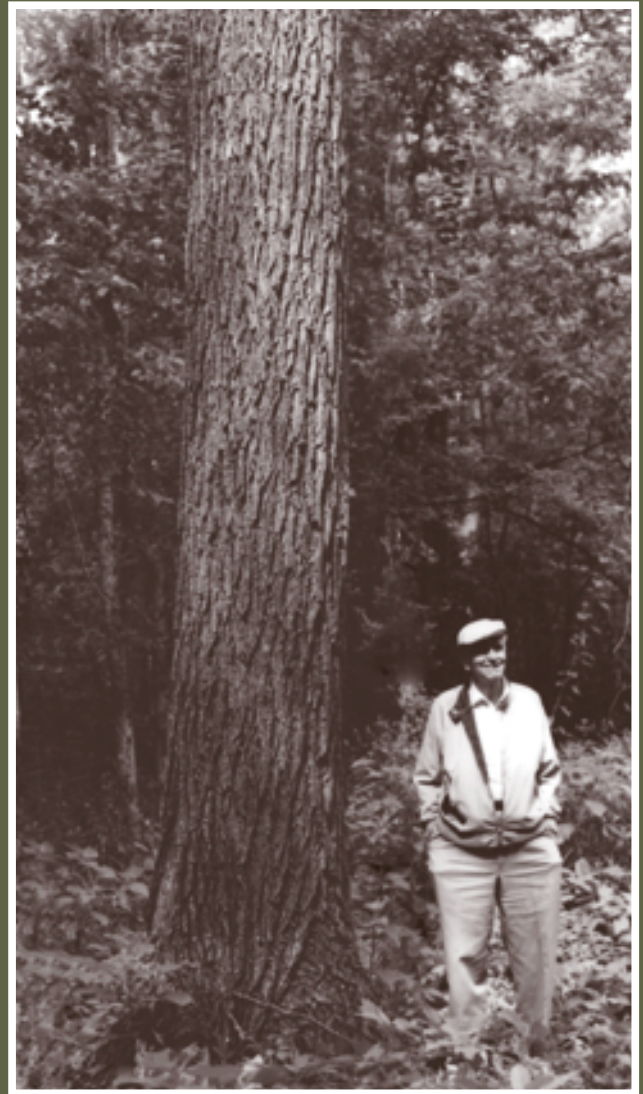

*A* top-quality black walnut veneer tree with more than 600 board feet.

# Veneer Markets

Markets for veneer are classified as markets for **veneer trees** and **veneer logs**. Forest owners are most concerned with markets for their veneer trees. Many wrongly informed landowners have mistakenly sold fine veneer trees as standard lumber trees, receiving a fraction of full market value. Landowners who are not expert at identifying, measuring and appraising veneer trees should seek the assistance of an experienced professional forester.

Most loggers, timber buyers and mill operators are potential markets for standing veneer trees. Such individuals often have direct markets with veneer mills, and for small quantities of veneer trees, are a landowner's best opportunity. However, when a timber sale has exceptional-quality veneer trees, or a large quantity of them, owners should extend beyond these markets and include the veneer mills (both domestic and export markets exist). Hardwood veneer buyers are scarce and there are very few hardwood veneer mills, particularly in the Southeast. This is why an experienced professional forester is needed.

Veneer logs are marketed for four major uses: architectural, secondary manufacturing, profile-wrapped moldings and paneling. The **architectural market** is for premium logs only – those without defects, longer lengths and a narrow, well-centered heart. Architectural veneer becomes wall and door paneling in executive offices and public buildings. Groups of veneer trees originating from the same forest are especially sought after for this market because their physical traits (color and texture) will be similar. These trees can be bulked and marketed together and used to fill large orders for the same building. The **secondary manufacturing market**, serving primarily the furniture, cabinet and flooring industry, is less rigid in quality specification than is the architectural market. Shorter lengths of veneer are used that can be cut between defects. Uniformity in wood color, however, is important for consistency in product. **Profile-wrapped molding market** is a market that fits between the previous two. This veneer is

wrapped or glued around reconstituted products such as fiberboard and is used to substitute for solid wood molding. **Wall paneling market** is the lowest class and includes 8-foot mismatched wall panels. Because panels do not need to match, some wood defects (if sound) are acceptable.

## Methods of Slicing Veneer

Manufacturing quality face veneer is highly specialized and capital-intensive, requiring watchful control on the quality of logs to be processed. Only the finest logs will pay for the cost of processing, a standard that varies with each mill. Three common methods of slicing hardwood veneer are flat slicing, half round and rotary cutting.

The finest decorative face veneers are produced from **flat slicing**. With this method, “flitches” are first created. Flitches are pieces of wood produced when a veneer log is halved or quartered (see Figures 2 and 3). The side of the flitch with the most aesthetically pleasing face is the side used to slice the veneer sheets. To make slicing easier, flitches are first heated in water vats to soften the wood. At the slicing machine, the flitch is held down (or dogged) into place on a metal frame that rapidly moves down against a long, stationary knife, producing thin sheets of veneer. **Half round** production also employs flitches; however, the flitch is rotated against the knife edge while being held in place on a half round machine. The half round machine resembles a lathe and produces slices the size of flitches. Sheets vary in thickness, but the standard for most domestic uses is 1/32 of an inch (thinner for export markets).

**Rotary cutting, also referred to as peeling**, is a method that is primarily used to manufacture commercial veneers for construction-grade plywood from softwood markets where strength, not appearance, is needed. With rotary cutting veneer, the log is turned against a giant lathe, unrolling the veneer into extended sheets as the log turns (much like unwinding a roll of paper). With hardwoods, it is used to produce core stock

for underlayment of finer flat-sliced stock, or it is stained or printed and finished to imitate a more expensive wood.

Veneer is processed in several other ways as well, including quarter-slicing, rift-cut and length-wise slicing. Each method produces a different visual effect, forming unique grain patterns.

*Figure 2.*



*A flitch is maneuvered into position on the half-round lathe in the veneer mill for slicing.*

*Figure 3.*



*Freshly stacked veneer ready to be clipped for the export market. This photo shows how veneer is stacked in the order of sequence as it is sliced from the flitch.*

## Criteria for Veneer Trees

Criteria for qualifying as a fine face veneer tree can be condensed into one precondition – top quality. Top quality is related to the amount and extent of **grade defects** found in the lower trunk of the tree. Typically veneer logs are only produced on the butt log (first log cut from the lower tree trunk). Grade defects are abnormalities that lower quality by reducing utility. Two types of grade defects are recognized: **exterior** and **interior**.

**Exterior grade defects** include abnormalities on the bark surface that can be seen. They indicate interior degrade, and include bumps, bulges, buttswell, knots, lesions and sweep (or curve). Holes (both large and very small, including bird

peck) are also exterior grade defects, as are seams caused by lightning, frost or drought. Perhaps the most difficult exterior grade defect to detect is dormant buds. These are very small recessed buds that exist along the trunk from which small sprouts (called epicormic branches) will periodically flush. If logs with dormant buds are processed into veneer slices, the resulting veneer slice will be of lower value. Refer to Figures 4 - 7 for some common exterior grade defects.